

64- Channel Probes

A1x48-Poly2-5mm-100s-177

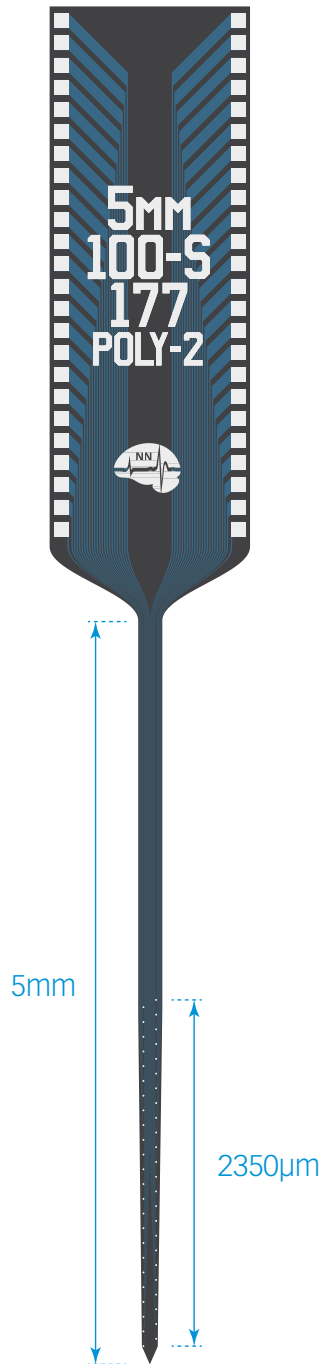

TIP DETAIL

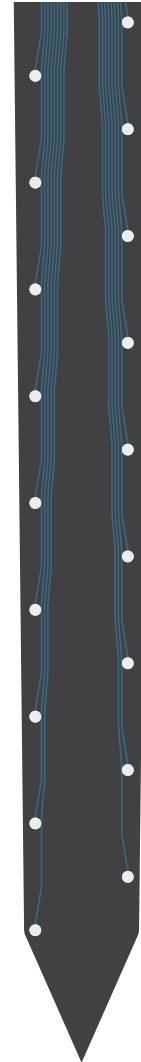

available packages

ACUTE
A64

CHRONIC
H64_30mm
H64LP_30mm
HC64_30mm
HZ64_30mm
Z64
X3-64
X3-H64_30mm

OPTOGENETICS
OA64LP
OA64LP_v2
OH64LP (oDrive)
OXA64LP
(Optogenix)

MR-COMPATIBLE
MR_H64_30mm
MR_HC64_30mm

ACTIVUS
AV64
AVI64
AVH64
AVIH64

SEARAY
SEACM64

Note: For H-package 64 channel designs: Unless otherwise requested you will receive a probe with up to 2 irregular sites. If you require a perfect probe, please specify when ordering.

thickness

15 µm

A1x64-Edge-6mm-20-177

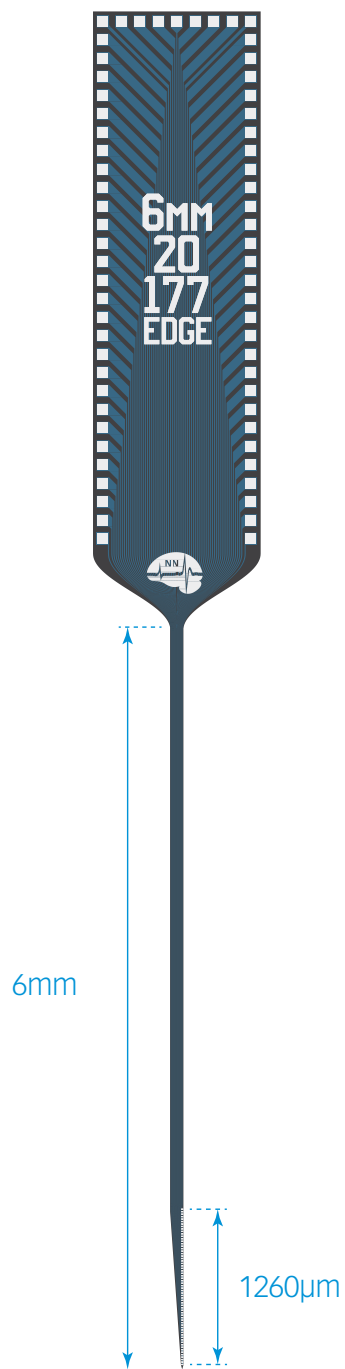

TIP DETAIL



available packages

ACUTE

A64

CHRONIC

H64_30mm
H64LP_30mm
HC64_30mm
HZ64_30mm
Z64
X3-64
X3-H64_30mm

OPTOGENETICS

OA64LP
OA64LP_v2
OH64LP (oDrive)
OXA64LP
(Optogenix)

MR-COMPATIBLE

MR_H64_30mm
MR_HC64_30mm

ACTIVUS

AV64
AVI64
AVH64
AVIH64

SEARAY

SEACM64

Note: For H-package 64 channel designs: Unless otherwise requested you will receive a probe with up to 2 irregular sites. If you require a perfect probe, please specify when ordering.

thickness

15 µm

A1X64-Edge-6mm-22.5-177

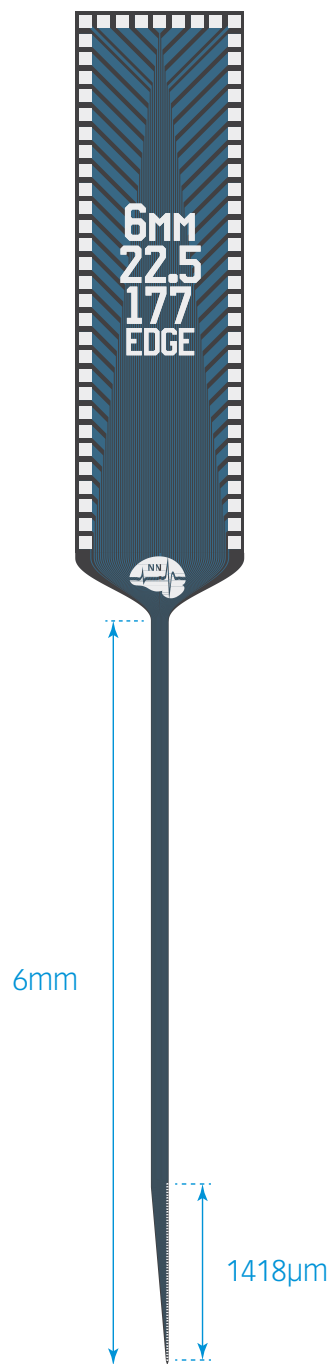

TIP DETAIL



available packages

ACUTE

A64

CHRONIC

H64_30mm
H64LP_30mm
HC64_30mm
HZ64_30mm
Z64
X3-64
X3-H64_30mm

OPTOGENETICS

OA64LP
OA64LP_v2
OH64LP (oDrive)
OXA64LP
(Optogenix)

MR-COMPATIBLE

MR_H64_30mm
MR_HC64_30mm

ACTIVUS

AV64
AVI64
AVH64
AVIH64

SEARAY

SEACM64

Note: For H-package 64 channel designs: Unless otherwise requested you will receive a probe with up to 2 irregular sites. If you require a perfect probe, please specify when ordering.

thickness

15 µm

A1x64-Edge-6mm-50-177

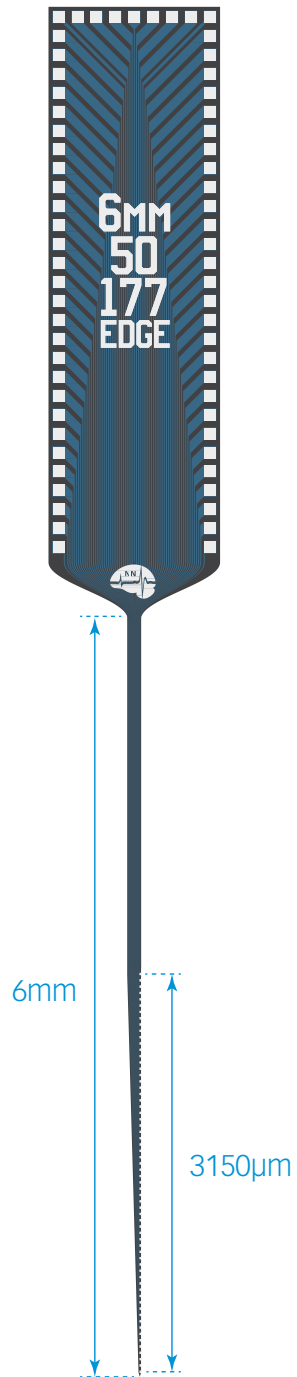

TIP DETAIL



available packages

ACUTE
A64

CHRONIC
H64_30mm
H64LP_30mm
HC64_30mm
HZ64_30mm
Z64
X3-64
X3-H64_30mm

OPTOGENETICS
OA64LP
OA64LP_v2
OH64LP (oDrive)
OXA64LP
(Optogenix)

MR-COMPATIBLE
MR_H64_30mm
MR_HC64_30mm

ACTIVUS
AV64
AVI64
AVH64
AVIH64

SEARAY
SEACM64

Note: For H-package 64 channel designs: Unless otherwise requested you will receive a probe with up to 2 irregular sites. If you require a perfect probe, please specify when ordering.

thickness

15 µm

A1X64-Poly2-6mm-23s-160

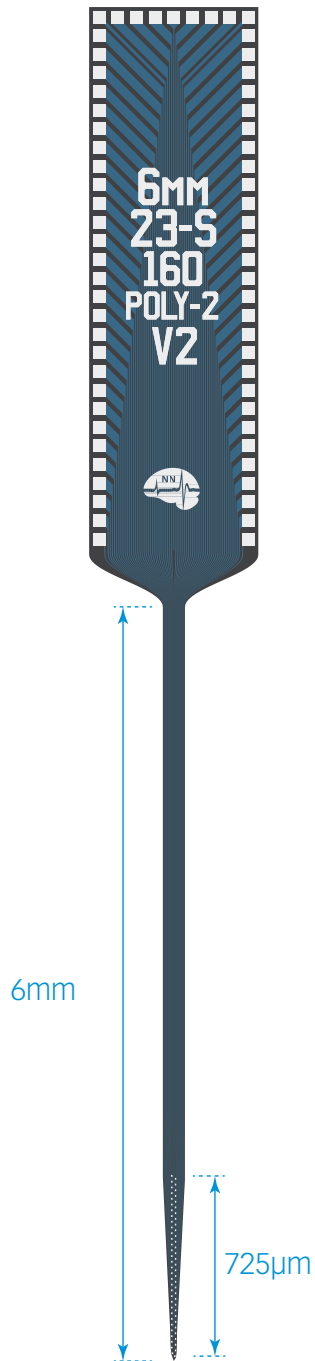

TIP DETAIL

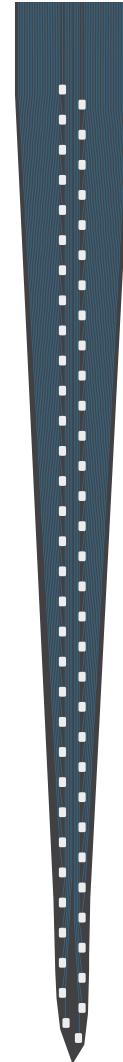

available packages

ACUTE
A64

CHRONIC
H64_30mm
H64LP_30mm
HC64_30mm
HZ64_30mm
Z64
X3-64
X3-H64_30mm

OPTOGENETICS
OA64LP
OA64LP_v2
OH64LP (oDrive)
OXA64LP
(Optogenix)

MR-COMPATIBLE
MR_H64_30mm
MR_HC64_30mm

ACTIVUS
AV64
AVI64
AVH64
AVIH64

SEARAY
SEACM64

Note: For H-package 64 channel designs: Unless otherwise requested you will receive a probe with up to 2 irregular sites. If you require a perfect probe, please specify when ordering.

thickness

15 µm
50 µm

A1X64-Poly2-12mm-60s-177

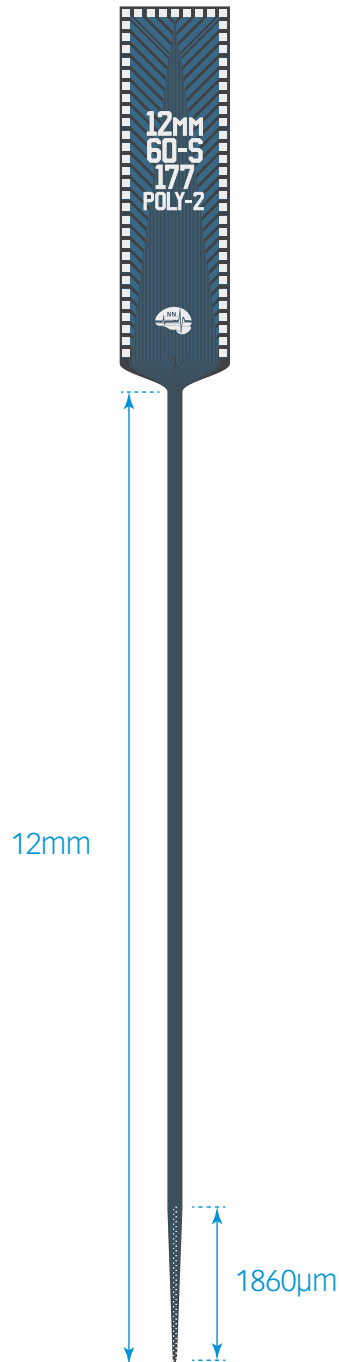

TIP DETAIL

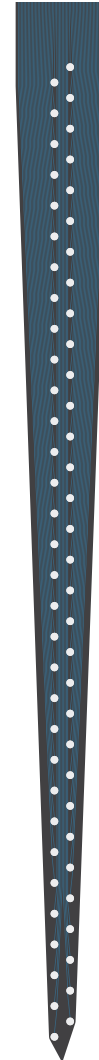

available packages

ACUTE
A64

CHRONIC
H64_30mm
H64LP_30mm
HC64_30mm
HZ64_30mm
Z64
X3-64
X3-H64_30mm

OPTOGENETICS
OA64LP
OA64LP_v2
OH64LP (oDrive)
OXA64LP
(Optogenix)

MR-COMPATIBLE
MR_H64_30mm
MR_HC64_30mm

ACTIVUS
AV64
AVI64
AVH64
AVIH64

SEARAY
SEACM64

Note: For H-package 64 channel designs: Unless otherwise requested you will receive a probe with up to 2 irregular sites. If you require a perfect probe, please specify when ordering.

thickness

50 µm

A2x32-5mm-25-200-177

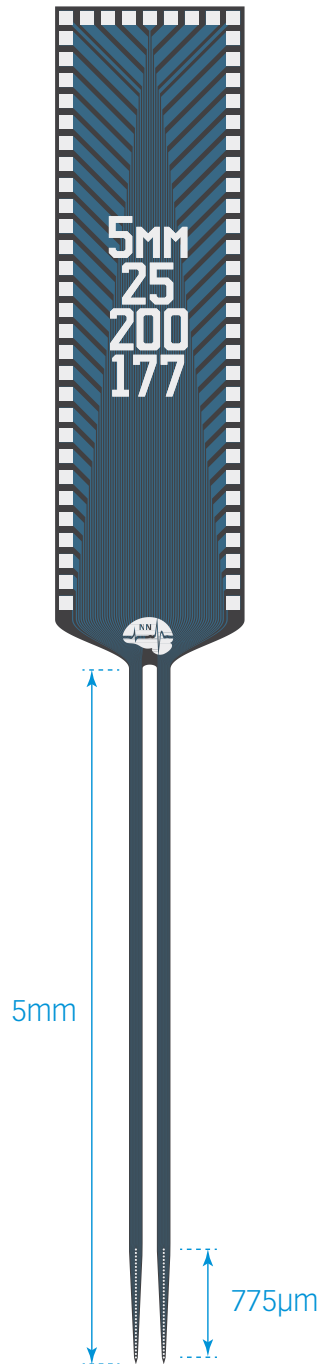

TIP DETAIL

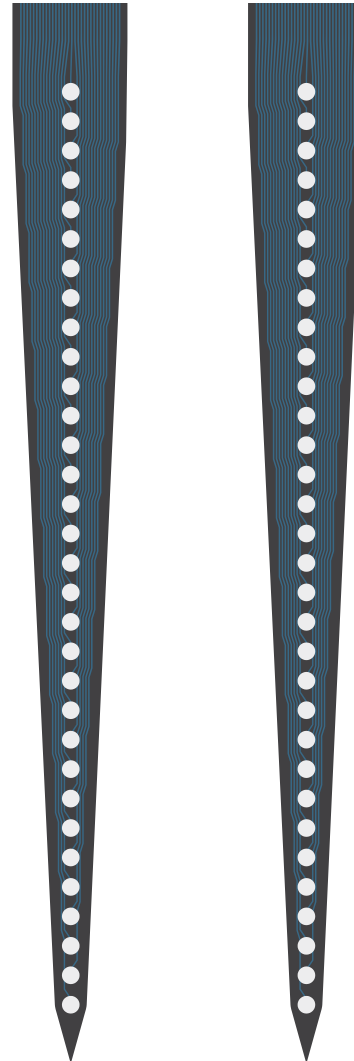

available packages

ACUTE

A64

CHRONIC

H64_30mm
H64LP_30mm
HC64_30mm
HZ64_30mm
Z64
X3-64
X3-H64_30mm

OPTOGENETICS

OA64LP
OA64LP_v2
OH64LP (oDrive)
OXA64LP
(Optogenix)

MR-COMPATIBLE

MR_H64_30mm
MR_HC64_30mm

ACTIVUS

AV64
AVI64
AVH64
AVIH64

SEARAY

SEACM64

Note: For H-package 64 channel designs: Unless otherwise requested you will receive a probe with up to 2 irregular sites. If you require a perfect probe, please specify when ordering.

thickness

15 µm

A2x32-6mm-35-200-177

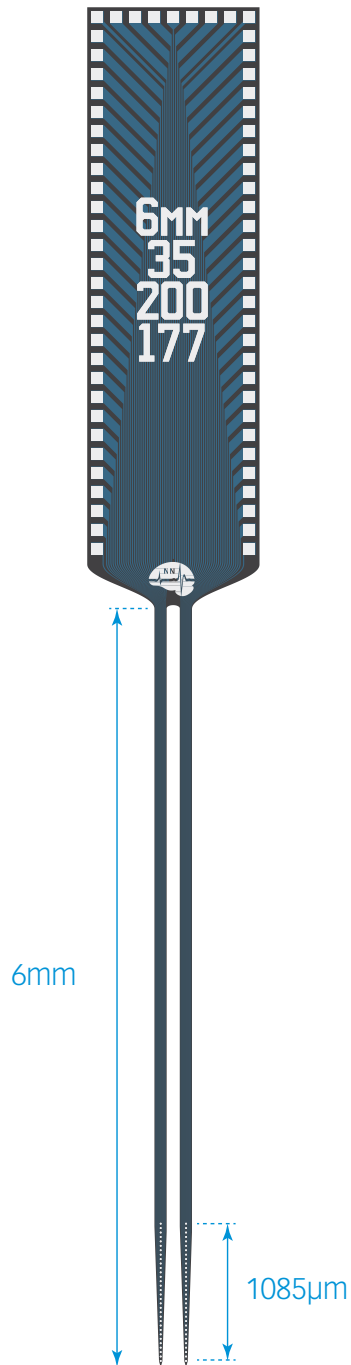

TIP DETAIL

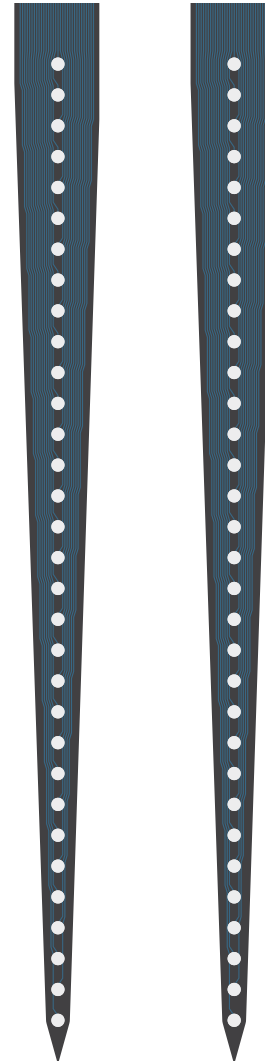

available packages

ACUTE
A64

CHRONIC
H64_30mm
H64LP_30mm
HC64_30mm
HZ64_30mm
Z64
X3-64
X3-H64_30mm

OPTOGENETICS
OA64LP
OA64LP_v2
OH64LP (oDrive)
OXA64LP
(Optogenix)

MR-COMPATIBLE
MR_H64_30mm
MR_HC64_30mm

ACTIVUS
AV64
AVI64
AVH64
AVIH64

SEARAY
SEACM64

Note: For H-package 64 channel designs: Unless otherwise requested you will receive a probe with up to 2 irregular sites. If you require a perfect probe, please specify when ordering.

thickness

50 µm

A2x32-15mm-100-200-177

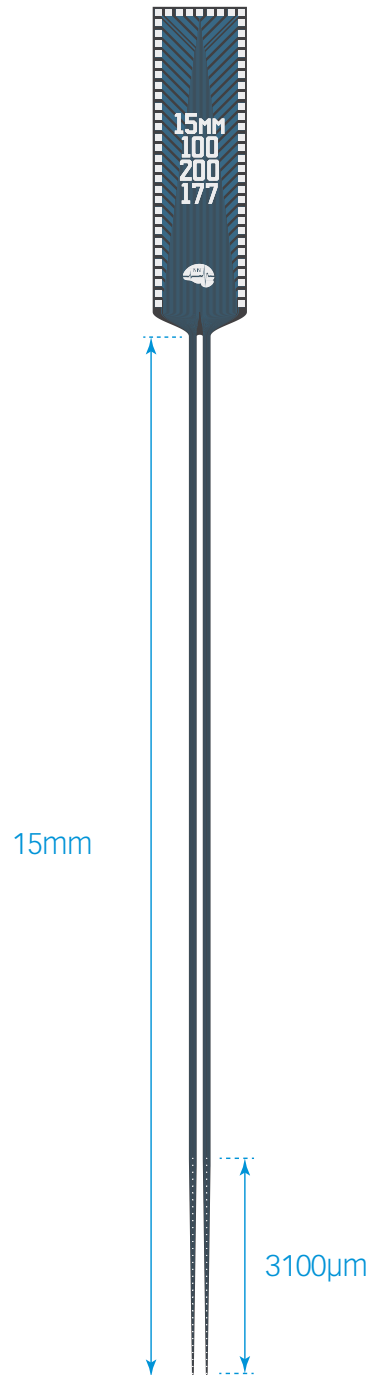

TIP DETAIL

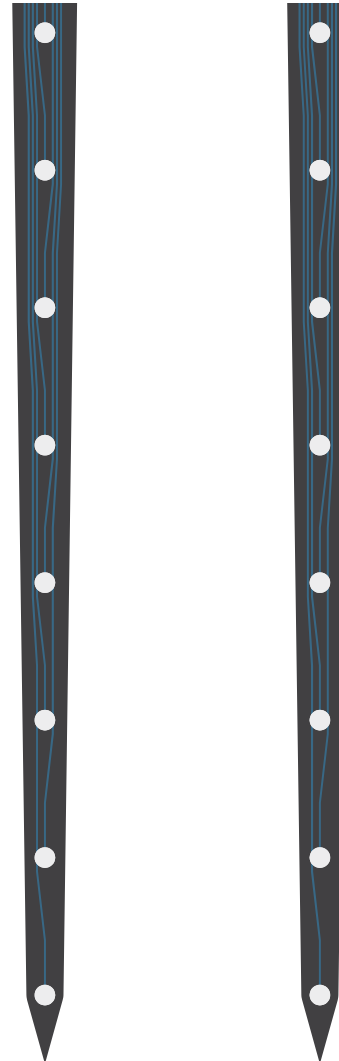

available packages

ACUTE
A64

CHRONIC
H64_30mm
H64LP_30mm
HC64_30mm
HZ64_30mm
Z64
X3-64
X3-H64_30mm

OPTOGENETICS
OA64LP
OA64LP_v2
OH64LP (oDrive)
OXA64LP
(Optogenix)

MR-COMPATIBLE
MR_H64_30mm
MR_HC64_30mm

ACTIVUS
AV64
AVI64
AVH64
AVIH64

SEARAY
SEACM64

Note: For H-package 64 channel designs: Unless otherwise requested you will receive a probe with up to 2 irregular sites. If you require a perfect probe, please specify when ordering.

thickness

50 µm

A4x16-2.5mm-tet/lin-300/125-333-121/177-parietal C

available packages

ACUTE A64

CHRONIC
H64_30mm
H64LP_30mm
HC64_30mm
HZ64_30mm
Z64
X3-64
X3-H64_30mm

OPTOGENETICS
OA64LP
OA64LP_v2
OH64LP (oDrive)
OXA64LP
(Optogenix)

MR-COMPATIBLE
MR_H64_30mm
MR_HC64_30mm

ACTIVUS
AV64
AVI64
AVH64
AVIH64

SEARAY
SEACM64

Note: For H-package 64 channel designs: Unless otherwise requested you will receive a probe with up to 2 irregular sites. If you require a perfect probe, please specify when ordering.

thickness

15 μ m

TIP DETAIL

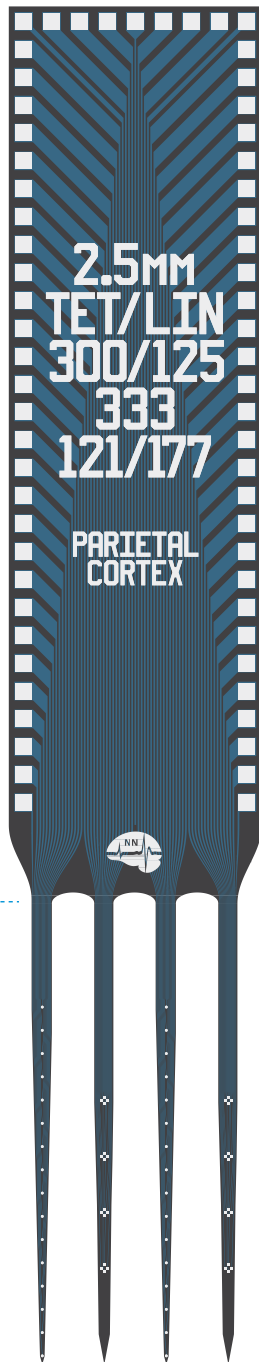
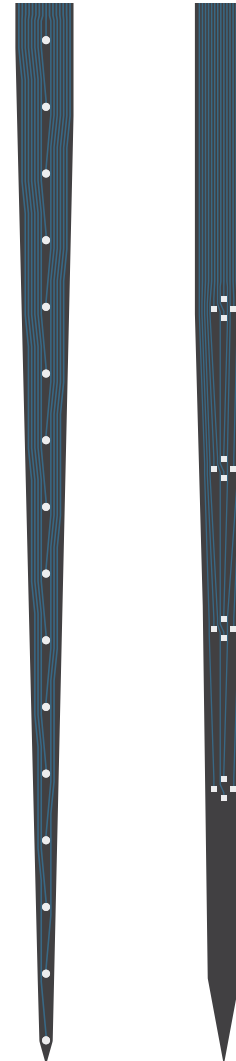

2.5mm

A4x16-3mm-50-200-177

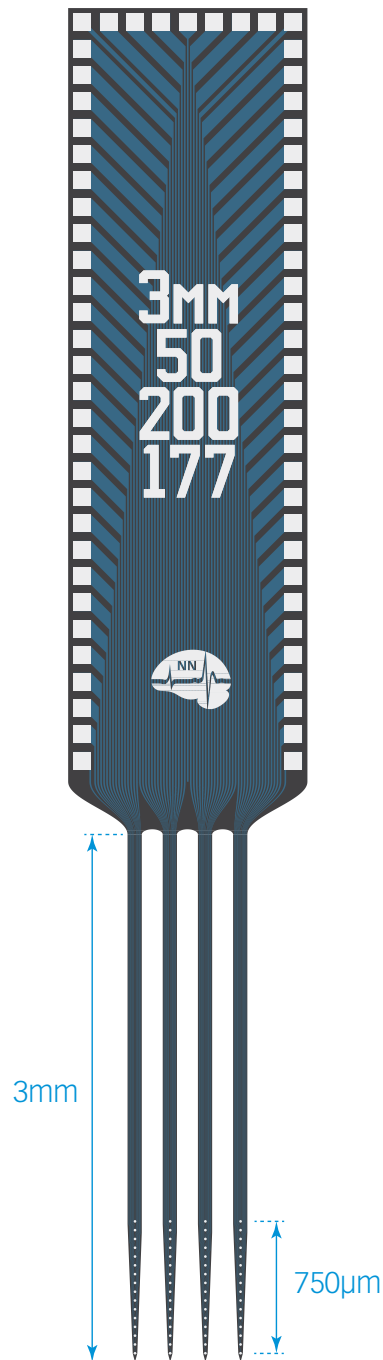

TIP DETAIL

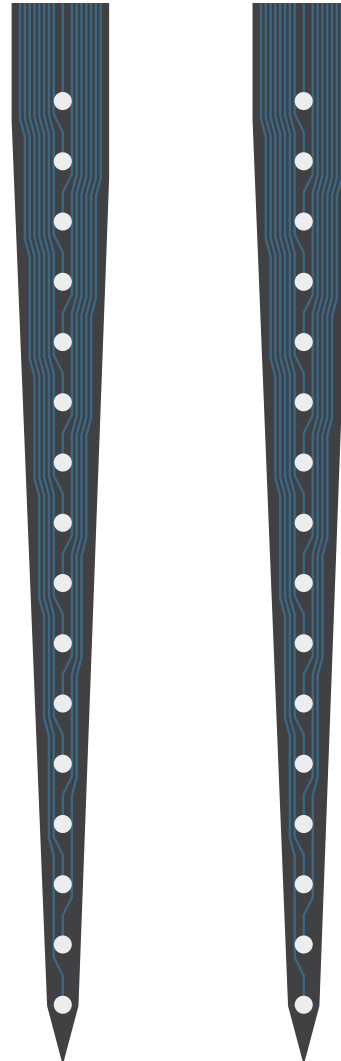

available packages

ACUTE
A64

CHRONIC
H64_30mm
H64LP_30mm
HC64_30mm
HZ64_30mm
Z64
X3-64
X3-H64_30mm

OPTOGENETICS
OA64LP
OA64LP_v2
OH64LP (oDrive)
OXA64LP
(Optogenix)

MR-COMPATIBLE
MR_H64_30mm
MR_HC64_30mm

ACTIVUS
AV64
AVI64
AVH64
AVIH64

SEARAY
SEACM64

Note: For H-package 64 channel designs: Unless otherwise requested you will receive a probe with up to 2 irregular sites. If you require a perfect probe, please specify when ordering.

thickness

15 µm

A4x16-3.6/3mm-50-430-177

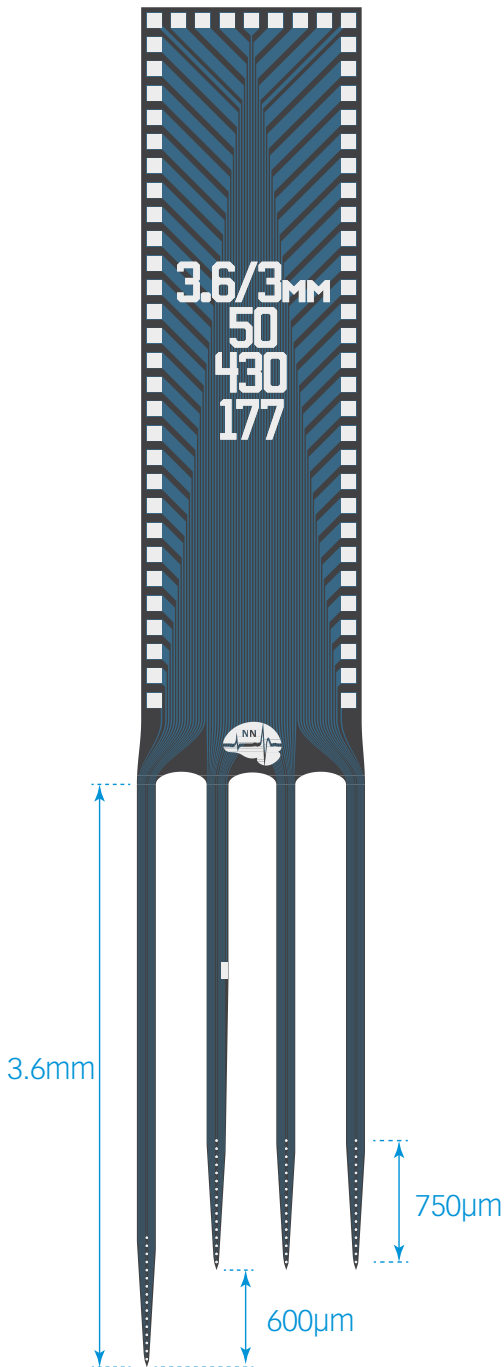

TIP DETAIL

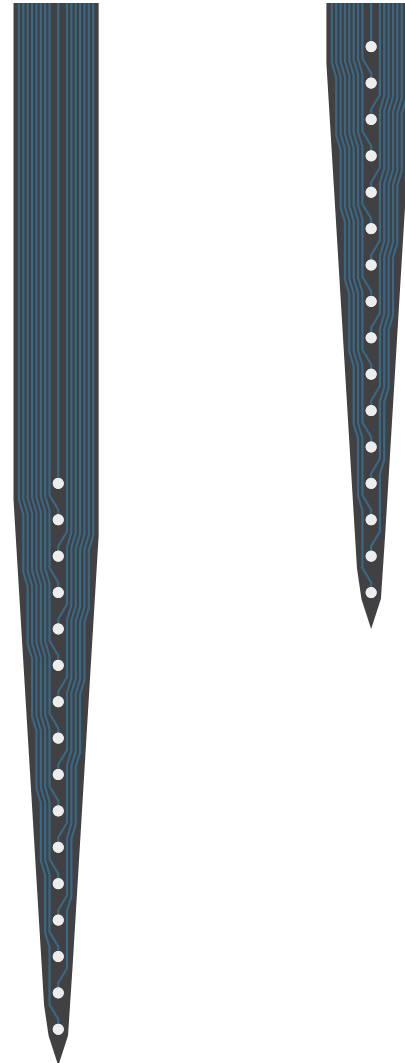

available packages

ACUTE
A64

CHRONIC
H64_30mm
H64LP_30mm
HC64_30mm
HZ64_30mm
Z64
X3-64
X3-H64_30mm

OPTOGENETICS
OA64LP
OA64LP_v2
OH64LP (oDrive)
OXA64LP
(Optogenix)

MR-COMPATIBLE
MR_H64_30mm
MR_HC64_30mm

ACTIVUS
AV64
AVI64
AVH64
AVIH64
SEARAY
SEACM64

Note: For H-package 64 channel designs: Unless otherwise requested you will receive a probe with up to 2 irregular sites. If you require a perfect probe, please specify when ordering.

thickness

15 µm

A4x16-Poly2-lin-5mm-20s-stag-190-160

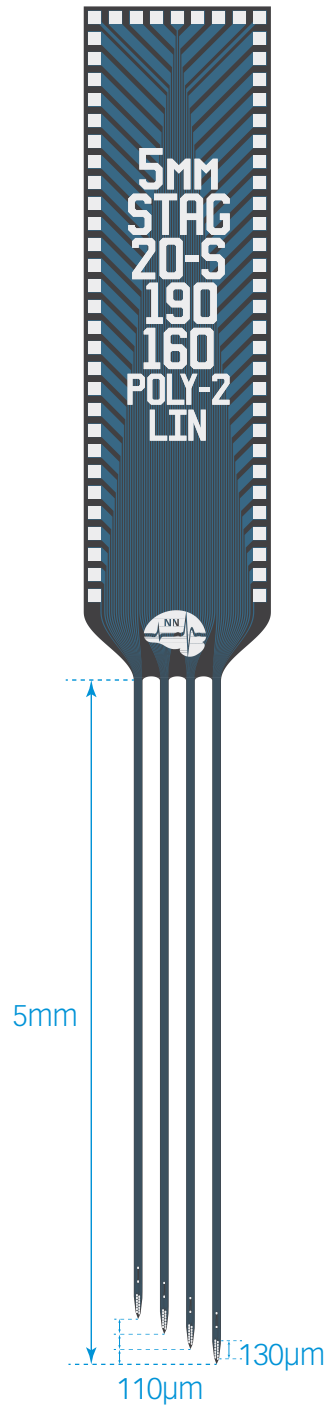

TIP DETAIL

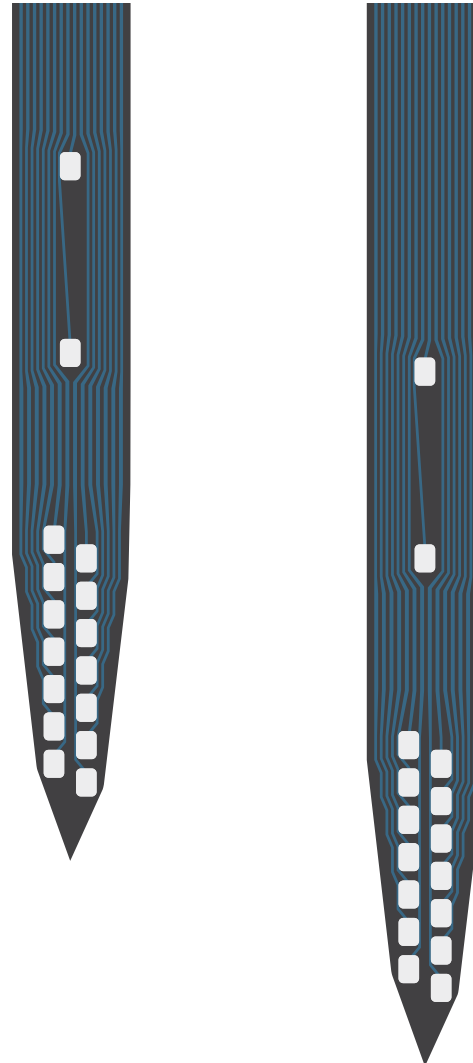

available packages

ACUTE
A64

CHRONIC
H64_30mm
H64LP_30mm
HC64_30mm
HZ64_30mm
Z64
X3-64
X3-H64_30mm

OPTOGENETICS
OA64LP
OA64LP_v2
OH64LP (oDrive)
OXA64LP
(Optogenix)

MR-COMPATIBLE
MR_H64_30mm
MR_HC64_30mm

ACTIVUS
AV64
AVI64
AVH64
AVIH64
SEARAY
SEACM64

Note: For H-package 64 channel designs: Unless otherwise requested you will receive a probe with up to 2 irregular sites. If you require a perfect probe, please specify when ordering.

thickness

15 µm

A4x16-5mm-50-200-177

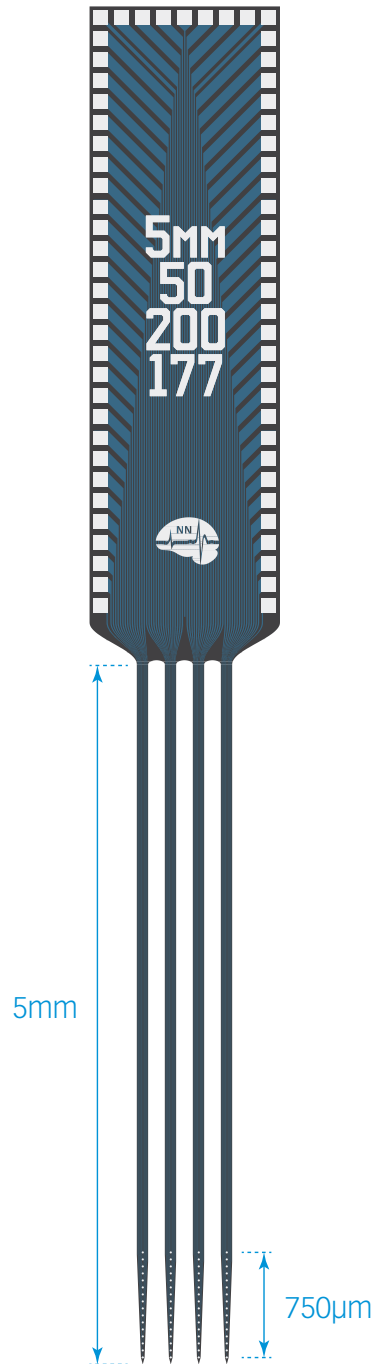

TIP DETAIL

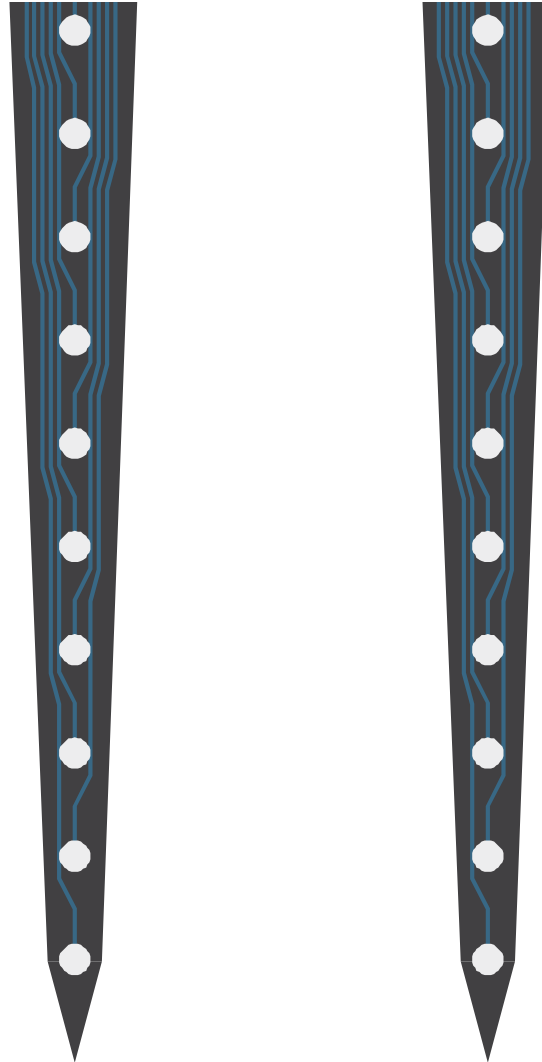

available packages

ACUTE
A64

CHRONIC
H64_30mm
H64LP_30mm
HC64_30mm
HZ64_30mm
Z64
X3-64
X3-H64_30mm

OPTOGENETICS
OA64LP
OA64LP_v2
OH64LP (oDrive)
OXA64LP
(Optogenix)

MR-COMPATIBLE
MR_H64_30mm
MR_HC64_30mm

ACTIVUS
AV64
AVI64
AVH64
AVIH64

SEARAY
SEACM64

Note: For H-package 64 channel designs: Unless otherwise requested you will receive a probe with up to 2 irregular sites. If you require a perfect probe, please specify when ordering.

thickness

15 µm

A4x16-5mm-50-250-177

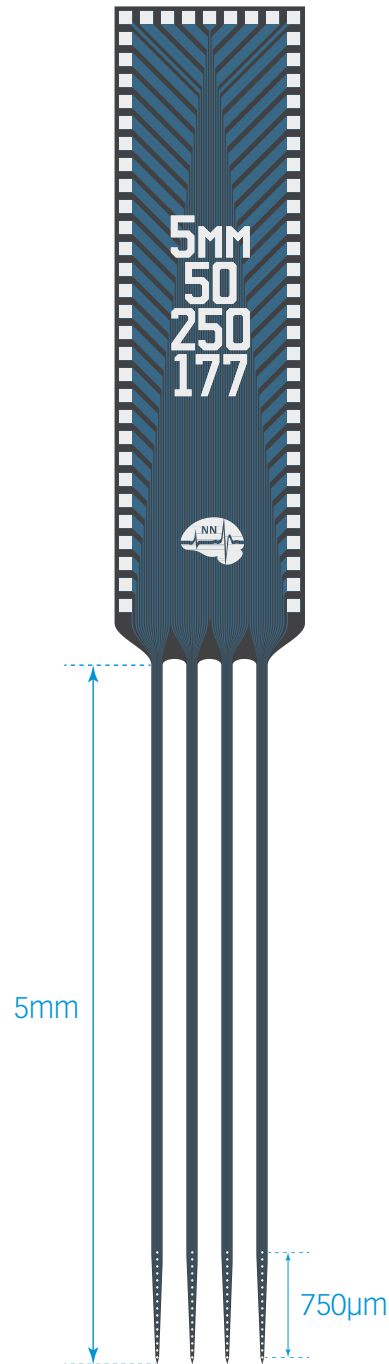

TIP DETAIL

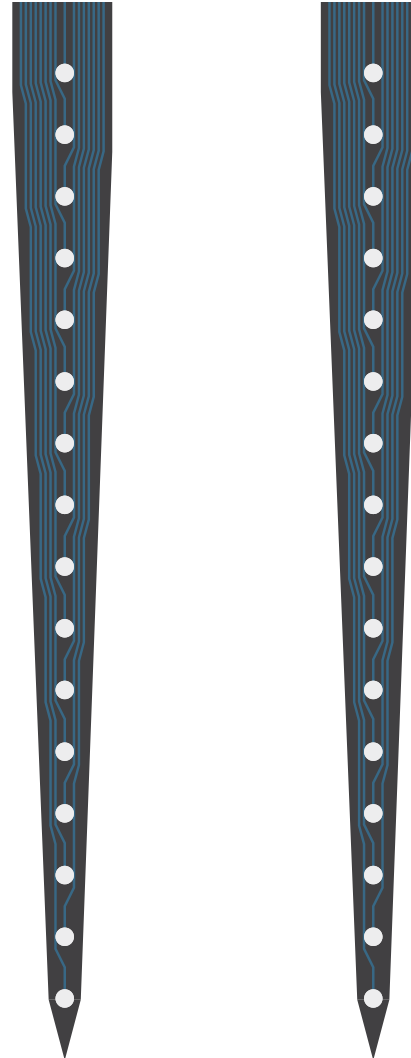

available packages

ACUTE
A64

CHRONIC
H64_30mm
H64LP_30mm
HC64_30mm
HZ64_30mm
Z64
X3-64
X3-H64_30mm

OPTOGENETICS
OA64LP
OA64LP_v2
OH64LP (oDrive)
OXA64LP
(Optogenix)

MR-COMPATIBLE
MR_H64_30mm
MR_HC64_30mm

ACTIVUS
AV64
AVI64
AVH64
AVIH64

SEARAY
SEACM64

Note: For H-package 64 channel designs: Unless otherwise requested you will receive a probe with up to 2 irregular sites. If you require a perfect probe, please specify when ordering.

thickness

15 µm

A4x16-5mm-50-500-703

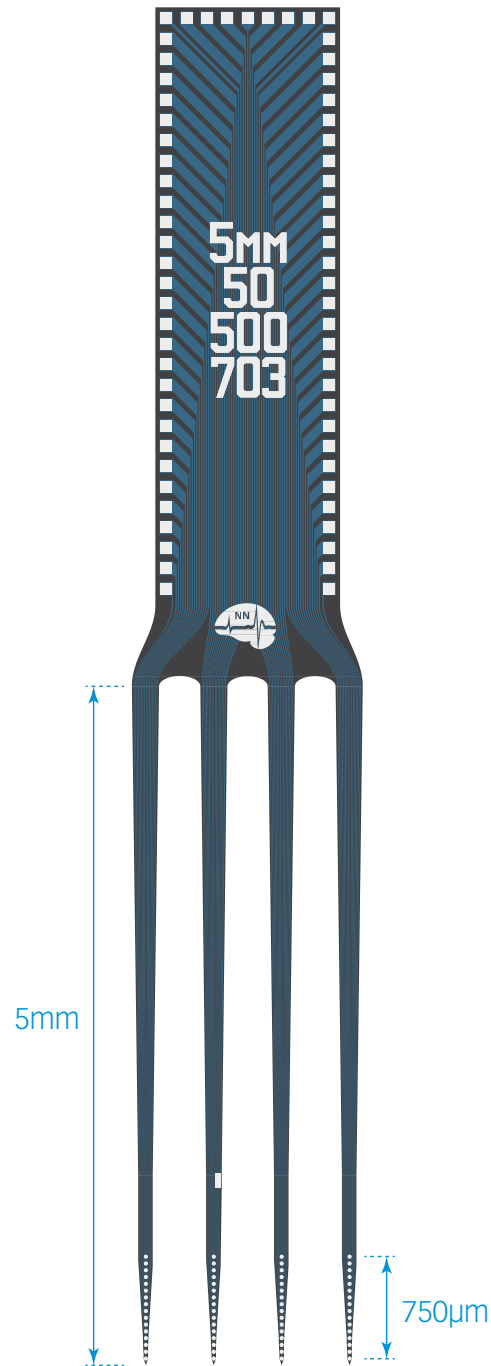

TIP DETAIL

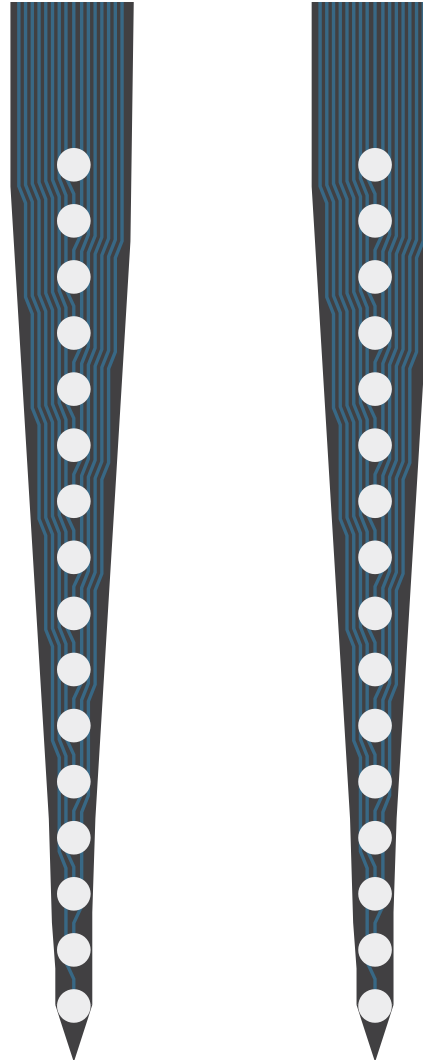

available packages

ACUTE
A64

CHRONIC
H64_30mm
H64LP_30mm
HC64_30mm
HZ64_30mm
Z64
X3-64
X3-H64_30mm

OPTOGENETICS
OA64LP
OA64LP_v2
OH64LP (oDrive)
OXA64LP
(Optogenix)

MR-COMPATIBLE
MR_H64_30mm
MR_HC64_30mm

ACTIVUS
AV64
AVI64
AVH64
AVIH64

SEARAY
SEACM64

Note: For H-package 64 channel designs: Unless otherwise requested you will receive a probe with up to 2 irregular sites. If you require a perfect probe, please specify when ordering.

thickness

15 µm

A4x16- Poly2-5mm-20s-150-160

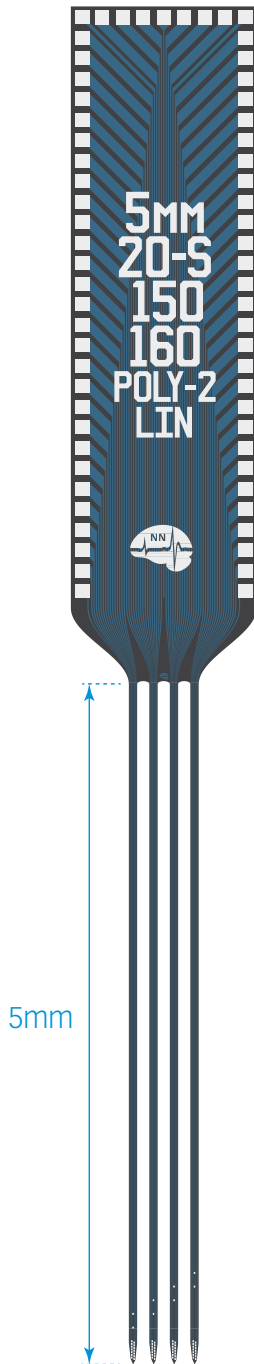

TIP DETAIL

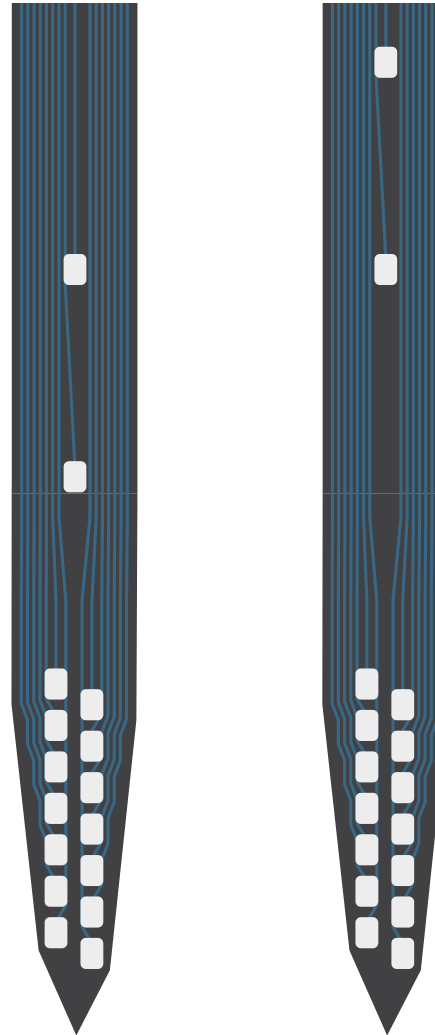

available
packages

ACUTE
A64

CHRONIC
H64_30mm
H64LP_30mm
HC64_30mm
HZ64_30mm
Z64
X3-64
X3-H64_30mm

OPTOGENETICS
OA64LP
OA64LP_v2
OH64LP (oDrive)
OXA64LP
(Optogenix)

MR-COMPATIBLE
MR_H64_30mm
MR_HC64_30mm

ACTIVUS
AV64
AVI64
AVH64
AVIH64
SEARAY
SEACM64

Note: For H-package 64 channel designs: Unless otherwise requested you will receive a probe with up to 2 irregular sites. If you require a perfect probe, please specify when ordering.

thickness

15 μ m

A4x16-Poly2-5mm-23s-200-177

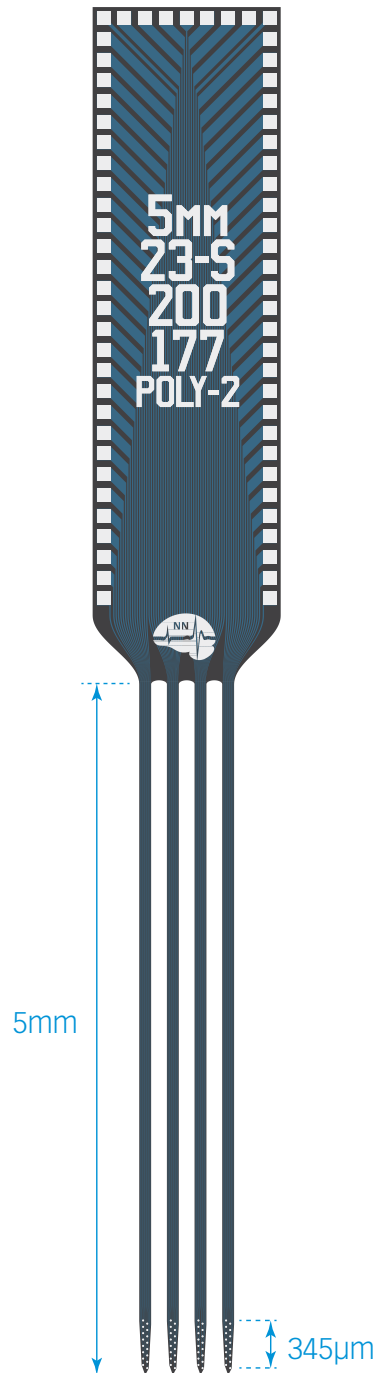

TIP DETAIL

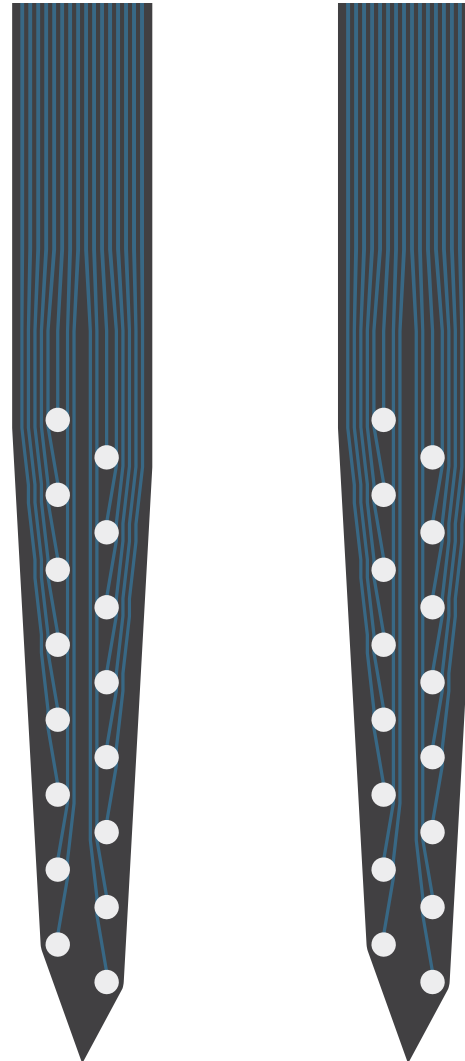

available packages

ACUTE

A64

CHRONIC

H64_30mm
H64LP_30mm
HC64_30mm
HZ64_30mm
Z64
X3-64
X3-H64_30mm

OPTOGENETICS

OA64LP
OA64LP_v2
OH64LP (oDrive)
OXA64LP
(Optogenix)

MR-COMPATIBLE

MR_H64_30mm
MR_HC64_30mm

ACTIVUS

AV64
AVI64
AVH64
AVIH64

SEARAY

SEACM64

Note: For H-package 64 channel designs: Unless otherwise requested you will receive a probe with up to 2 irregular sites. If you require a perfect probe, please specify when ordering.

thickness

15 µm

A4x16- Poly3-5mm-20s-200-160

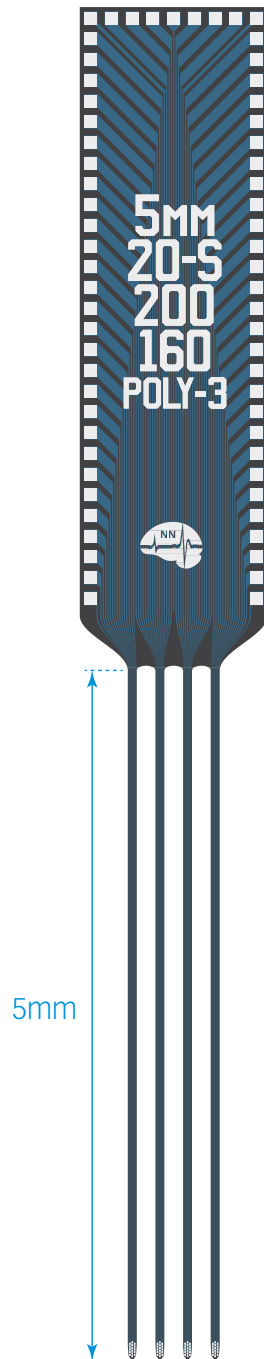

TIP DETAIL

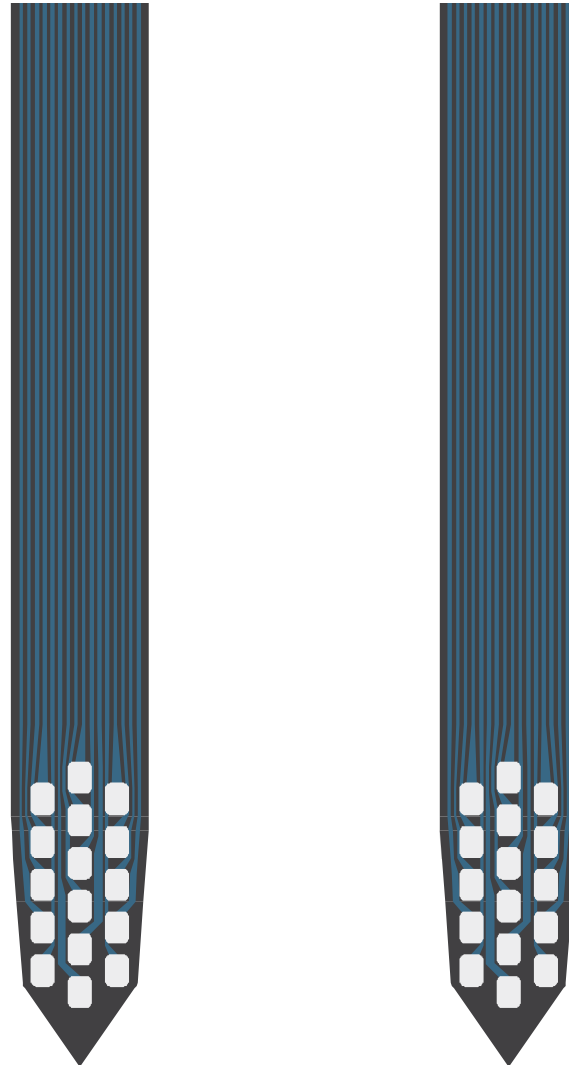

available packages

ACUTE A64

CHRONIC
H64_30mm
H64LP_30mm
HC64_30mm
HZ64_30mm
Z64
X3-64
X3-H64_30mm

OPTOGENETICS
OA64LP
OA64LP_v2
OH64LP (oDrive)
OXA64LP
(Optogenix)

MR-COMPATIBLE
MR_H64_30mm
MR_HC64_30mm

ACTIVUS
AV64
AVI64
AVH64
AVIH64
SEARAY
SEACM64

Note: For H-package 64 channel designs: Unless otherwise requested you will receive a probe with up to 2 irregular sites. If you require a perfect probe, please specify when ordering.

thickness

15 μ m

A4x4-tet-5mm-150-200-121

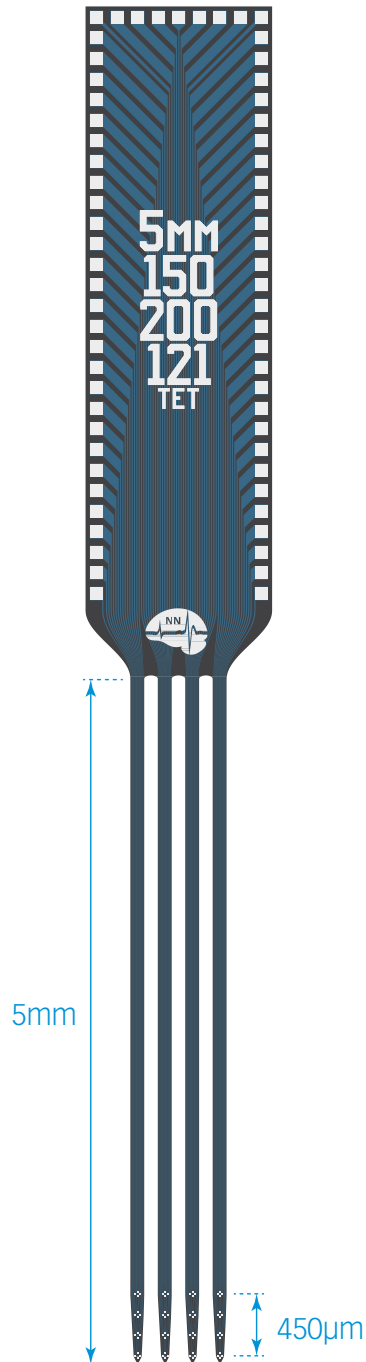

TIP DETAIL

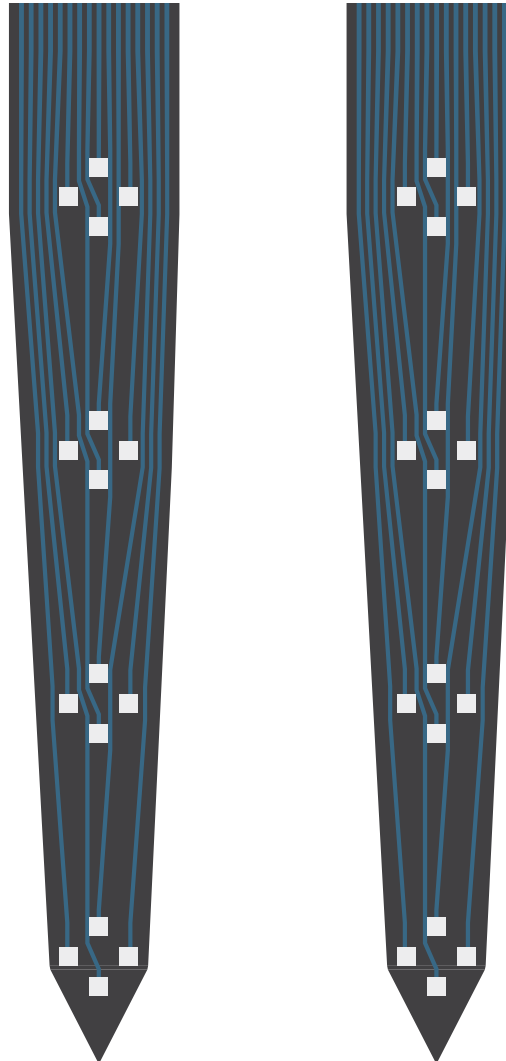

available packages

ACUTE
A64

CHRONIC
H64_30mm
H64LP_30mm
HC64_30mm
HZ64_30mm
Z64
X3-64
X3-H64_30mm

OPTOGENETICS
OA64LP
OA64LP_v2
OH64LP (oDrive)
OXA64LP
(Optogenix)

MR-COMPATIBLE
MR_H64_30mm
MR_HC64_30mm

ACTIVUS
AV64
AVI64
AVH64
AVIH64

SEARAY
SEACM64

Note: For H-package 64 channel designs: Unless otherwise requested you will receive a probe with up to 2 irregular sites. If you require a perfect probe, please specify when ordering.

thickness

15 µm

A4x16-6mm-50-200-177

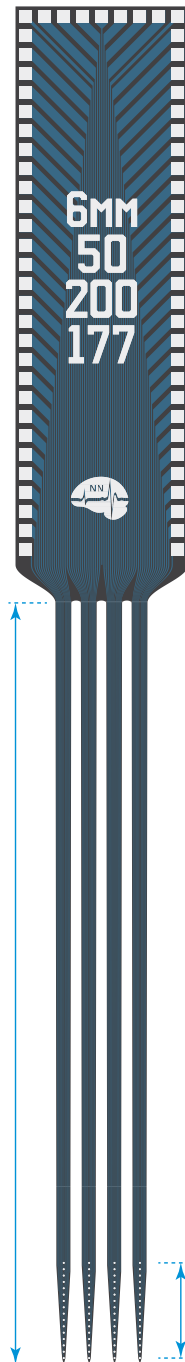

TIP DETAIL

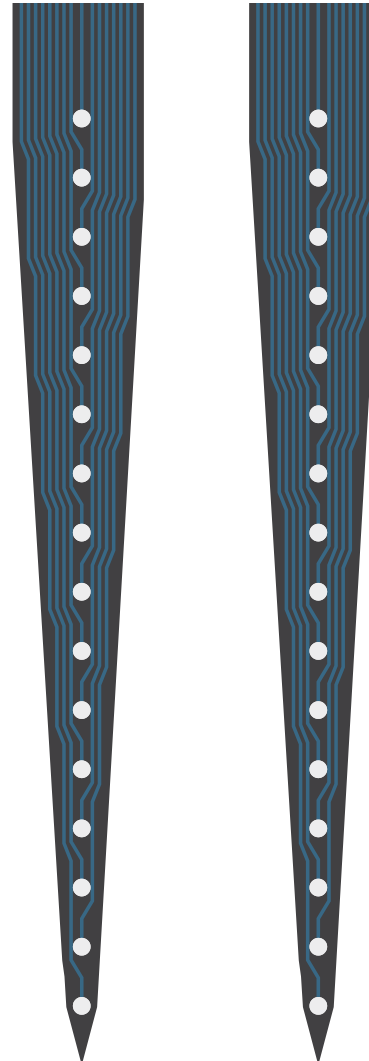

available packages

ACUTE
A64

CHRONIC
H64_30mm
H64LP_30mm
HC64_30mm
HZ64_30mm
Z64
X3-64
X3-H64_30mm

OPTOGENETICS
OA64LP
OA64LP_v2
OH64LP (oDrive)
OXA64LP
(Optogenix)

MR-COMPATIBLE
MR_H64_30mm
MR_HC64_30mm

ACTIVUS
AV64
AVI64
AVH64
AVIH64

SEARAY
SEACM64

Note: For H-package 64 channel designs: Unless otherwise requested you will receive a probe with up to 2 irregular sites. If you require a perfect probe, please specify when ordering.

thickness

15 µm

A4x16-6mm-tet/lin- Colliculus Striatum

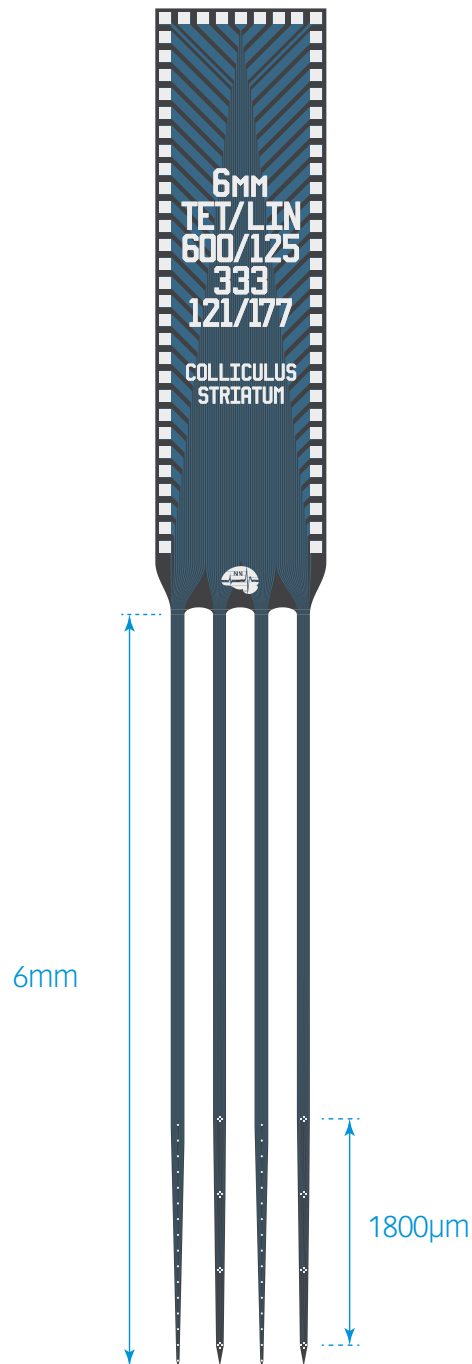

TIP DETAIL

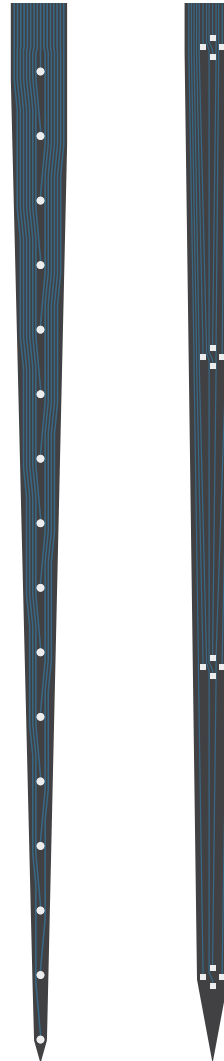

available packages

ACUTE A64

CHRONIC
H64_30mm
H64LP_30mm
HC64_30mm
HZ64_30mm
Z64
X3-64
X3-H64_30mm

OPTOGENETICS

OA64LP
OA64LP_v2
OH64LP (oDrive)
OXA64LP
(Optogenix)

MR-COMPATIBLE

MR_H64_30mm
MR_HC64_30mm

ACTIVUS

AV64
AVI64
AVH64
AVIH64

SEARAY

SEACM64

Note: For H-package 64 channel designs: Unless otherwise requested you will receive a probe with up to 2 irregular sites. If you require a perfect probe, please specify when ordering.

thickness

15 µm

A4x16-6mm-tet/lin- prefrontal cortex

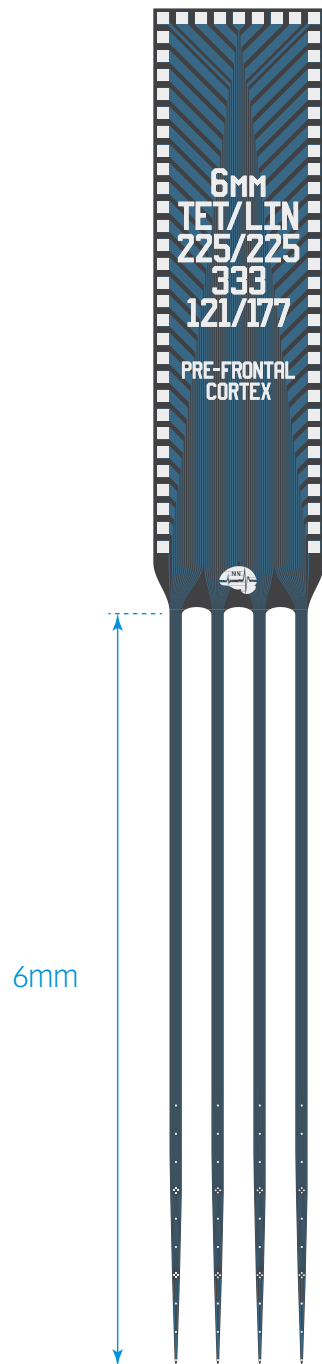

TIP DETAIL

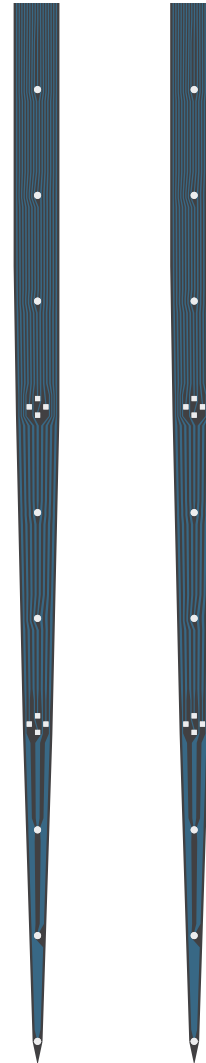

available packages

ACUTE A64

CHRONIC
H64_30mm
H64LP_30mm
HC64_30mm
HZ64_30mm
Z64
X3-64
X3-H64_30mm

OPTOGENETICS

OA64LP
OA64LP_v2
OH64LP (oDrive)
OXA64LP
(Optogenix)

MR-COMPATIBLE

MR_H64_30mm
MR_HC64_30mm

ACTIVUS

AV64
AVI64
AVH64
AVIH64

SEARAY

SEACM64

Note: For H-package 64 channel designs: Unless otherwise requested you will receive a probe with up to 2 irregular sites. If you require a perfect probe, please specify when ordering.

thickness

15 μ m

A4x16-Poly2-6mm-20s- stag-190-160

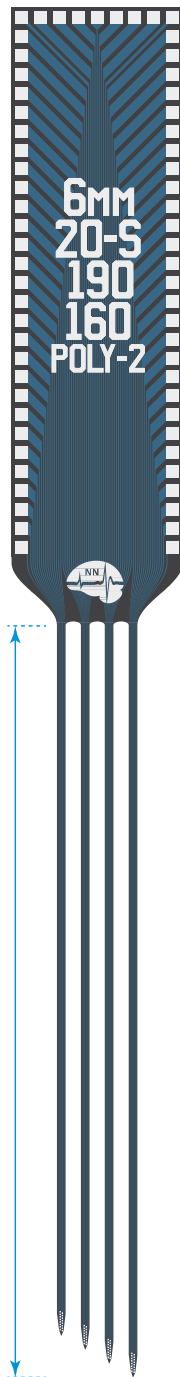

TIP DETAIL

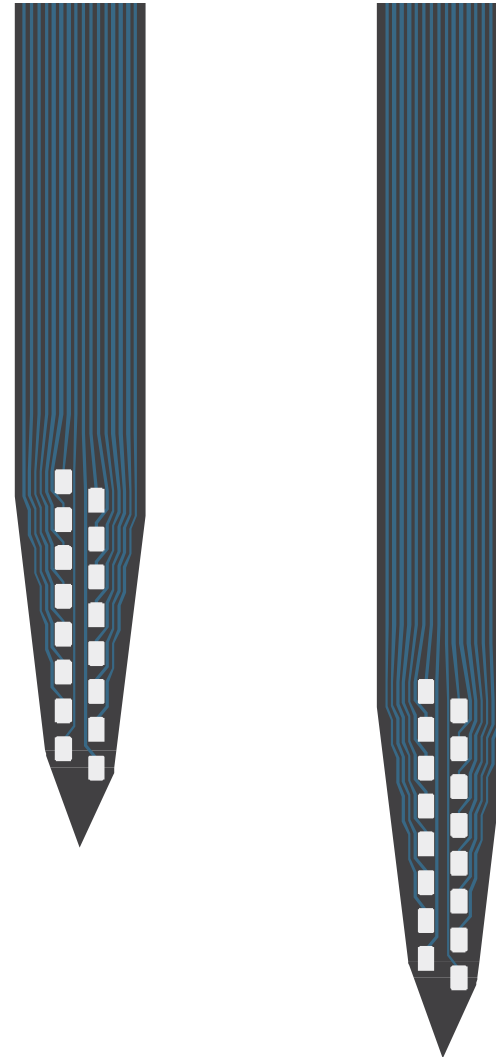

available packages

ACUTE
A64

CHRONIC
H64_30mm
H64LP_30mm
HC64_30mm
HZ64_30mm
Z64
X3-64
X3-H64_30mm

OPTOGENETICS
OA64LP
OA64LP_v2
OH64LP (oDrive)
OXA64LP
(Optogenix)

MR-COMPATIBLE
MR_H64_30mm
MR_HC64_30mm

ACTIVUS
AV64
AVI64
AVH64
AVIH64
SEARAY
SEACM64

Note: For H-package 64 channel designs: Unless otherwise requested you will receive a probe with up to 2 irregular sites. If you require a perfect probe, please specify when ordering.

thickness

15 μ m

A4x16-7.5mm-250-1000-177-grid

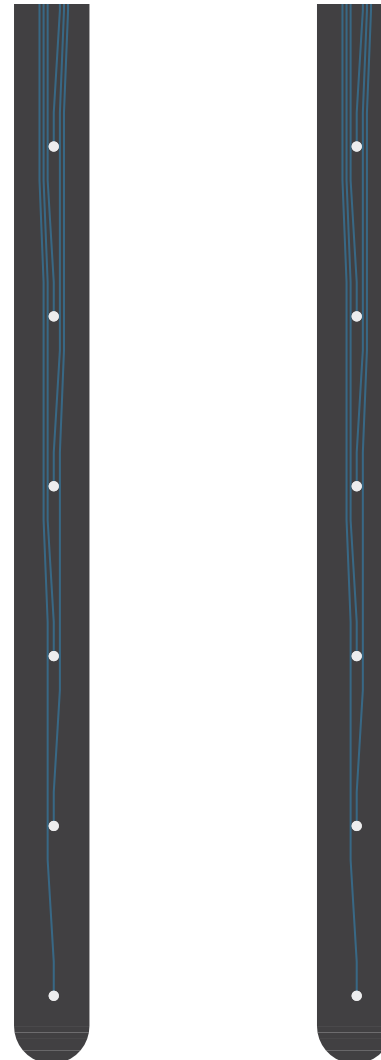
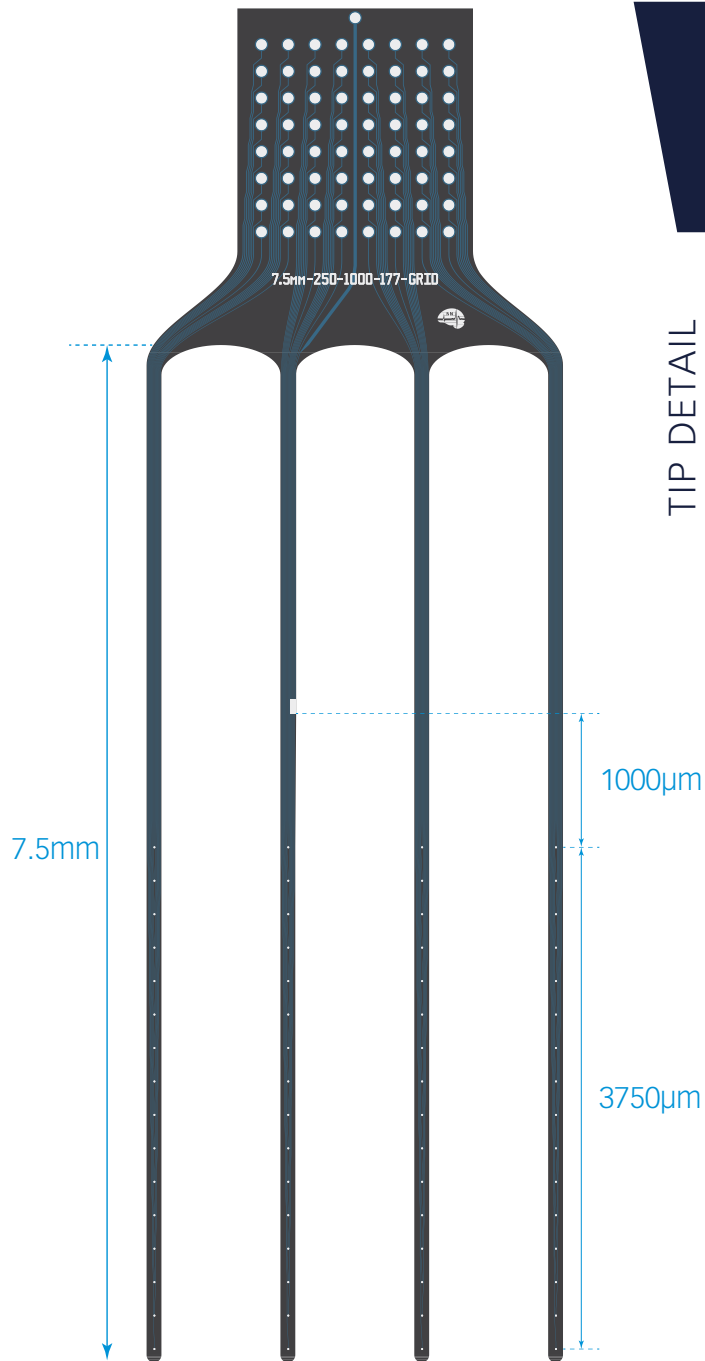

available packages

ACUTE

A64

CHRONIC
H64_30mm
H64LP_30mm
HC64_30mm
HZ64_30mm
Z64
X3-64
X3-H64_30mm

OPTOGENETICS

OA64LP
OA64LP_v2
OH64LP (oDrive)
OXA64LP
(Optogenix)

MR-COMPATIBLE

MR_H64_30mm
MR_HC64_30mm

ACTIVUS

AV64
AVI64
AVH64
AVIH64

SEARAY

SEACM64

Note: For H-package 64 channel designs: Unless otherwise requested you will receive a probe with up to 2 irregular sites. If you require a perfect probe, please specify when ordering.

thickness

50 µm

A4x4-tet-10mm-250-200-121

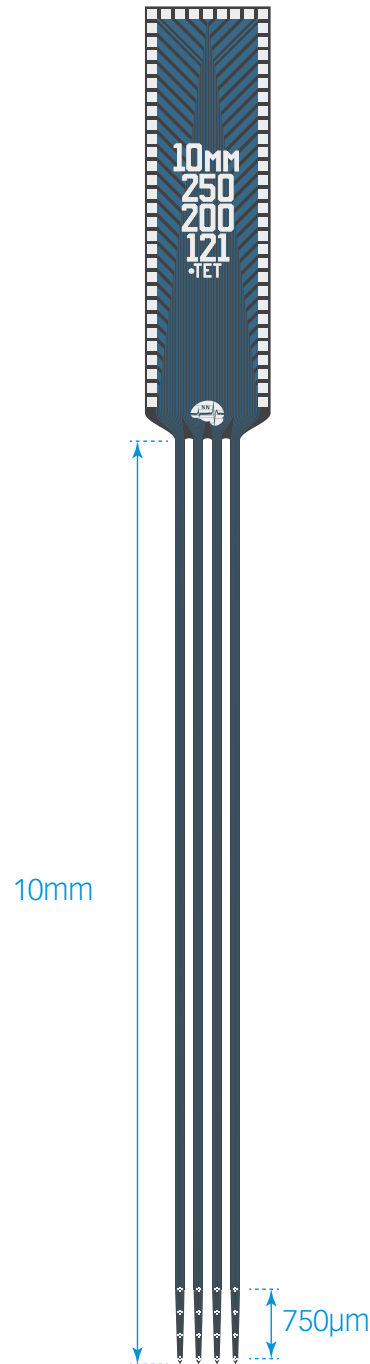

TIP DETAIL

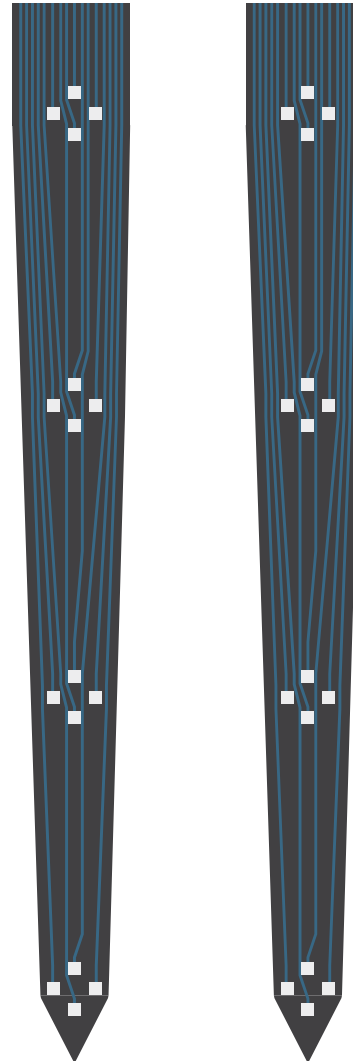

available packages

ACUTE A64

CHRONIC
H64_30mm
H64LP_30mm
HC64_30mm
HZ64_30mm
Z64
X3-64
X3-H64_30mm

OPTOGENETICS
OA64LP
OA64LP_v2
OH64LP (oDrive)
OXA64LP
(Optogenix)

MR-COMPATIBLE
MR_H64_30mm
MR_HC64_30mm

ACTIVUS
AV64
AVI64
AVH64
AVIH64

SEARAY
SEACM64

Note: For H-package 64 channel designs: Unless otherwise requested you will receive a probe with up to 2 irregular sites. If you require a perfect probe, please specify when ordering.

thickness

50 µm

A4x4-tet-10.6mm-333-250-121

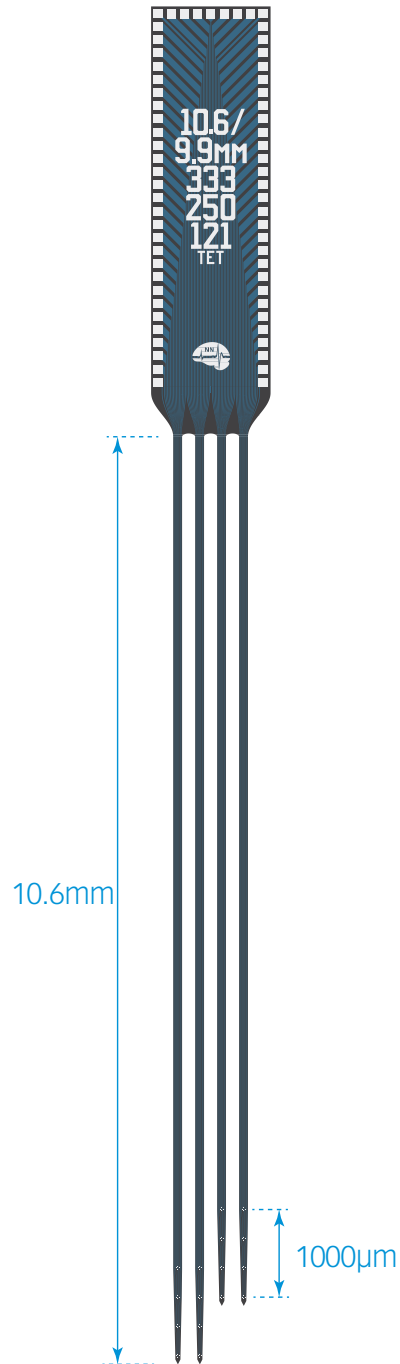

TIP DETAIL

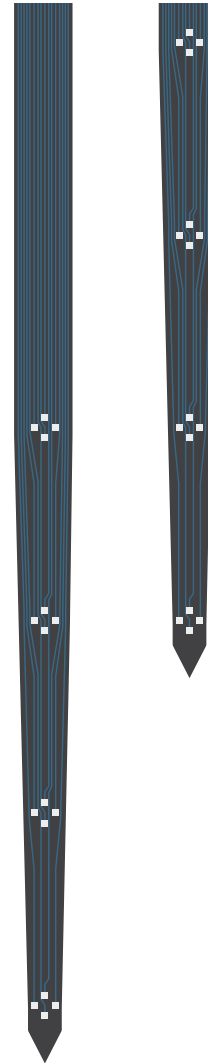

available packages

ACUTE A64

CHRONIC
H64_30mm
H64LP_30mm
HC64_30mm
HZ64_30mm
Z64
X3-64
X3-H64_30mm

OPTOGENETICS

OA64LP
OA64LP_v2
OH64LP (oDrive)
OXA64LP
(Optogenix)

MR-COMPATIBLE

MR_H64_30mm
MR_HC64_30mm

ACTIVUS

AV64
AVI64
AVH64
AVIH64

SEARAY SEACM64

Note: For H-package 64 channel designs: Unless otherwise requested you will receive a probe with up to 2 irregular sites. If you require a perfect probe, please specify when ordering.

thickness

50 µm

A5x12/16-buz/lin-3/4mm- 100-200-160/177

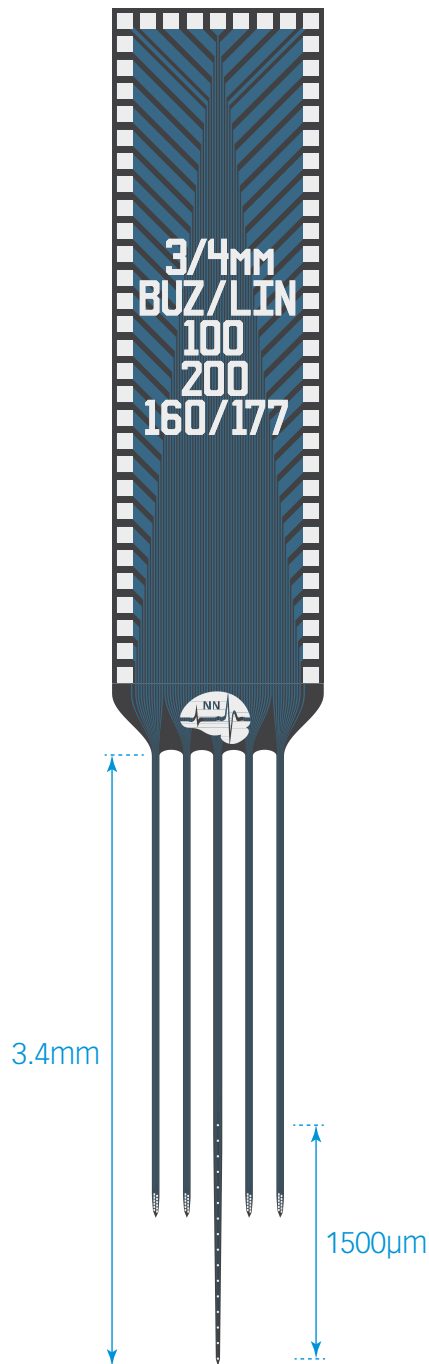

TIP DETAIL

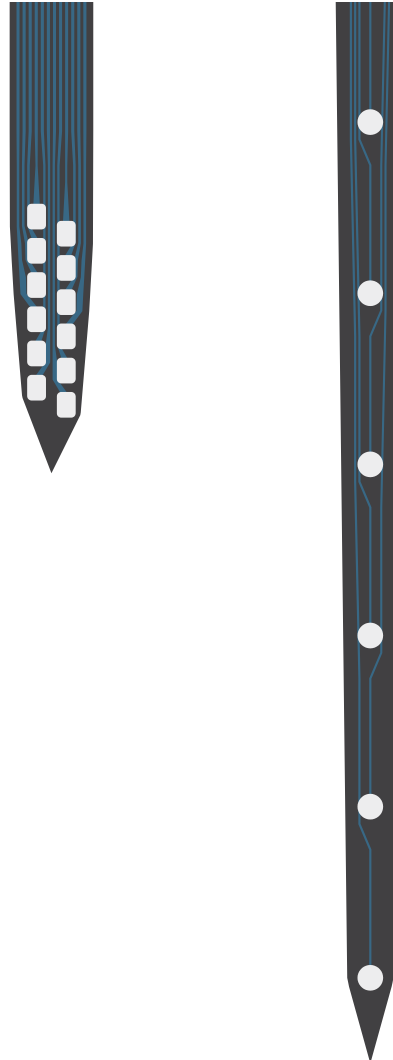

available packages

ACUTE A64

CHRONIC
H64_30mm
H64LP_30mm
HC64_30mm
HZ64_30mm
Z64
X3-64
X3-H64_30mm

OPTOGENETICS
OA64LP
OA64LP_v2
OH64LP (oDrive)
OXA64LP
(Optogenix)

MR-COMPATIBLE
MR_H64_30mm
MR_HC64_30mm

ACTIVUS
AV64
AVI64
AVH64
AVIH64

SEARAY
SEACM64

Note: For H-package 64 channel designs: Unless otherwise requested you will receive a probe with up to 2 irregular sites. If you require a perfect probe, please specify when ordering.

thickness

15 µm

A5x12/16-buz/lin-5mm-100- 200-160

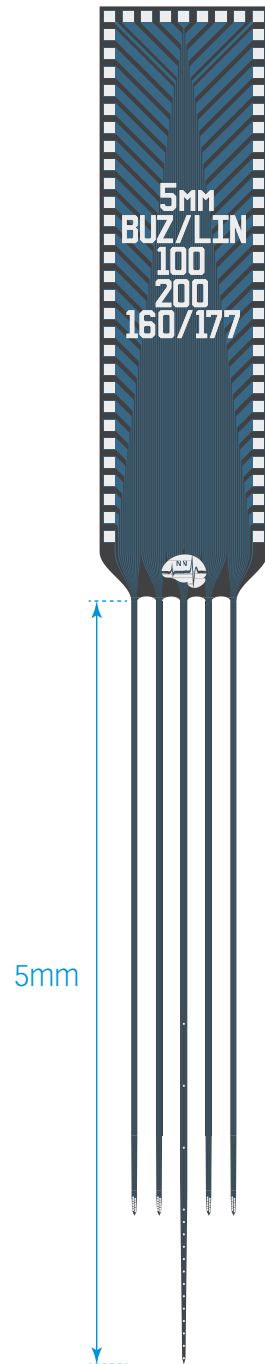

TIP DETAIL

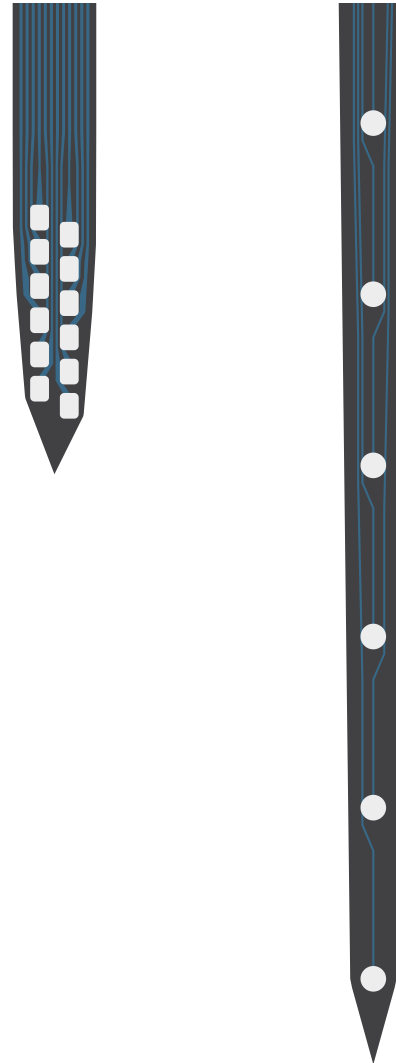

available packages

ACUTE
A64

CHRONIC
H64_30mm
H64LP_30mm
HC64_30mm
HZ64_30mm
Z64
X3-64
X3-H64_30mm

OPTOGENETICS
OA64LP
OA64LP_v2
OH64LP (oDrive)
OXA64LP
(Optogenix)

MR-COMPATIBLE
MR_H64_30mm
MR_HC64_30mm

ACTIVUS
AV64
AVI64
AVH64
AVIH64
SEARAY
SEACM64

Note: For H-package 64 channel designs: Unless otherwise requested you will receive a probe with up to 2 irregular sites. If you require a perfect probe, please specify when ordering.

thickness

15 μ m

A12x5-5mm-200-200-177

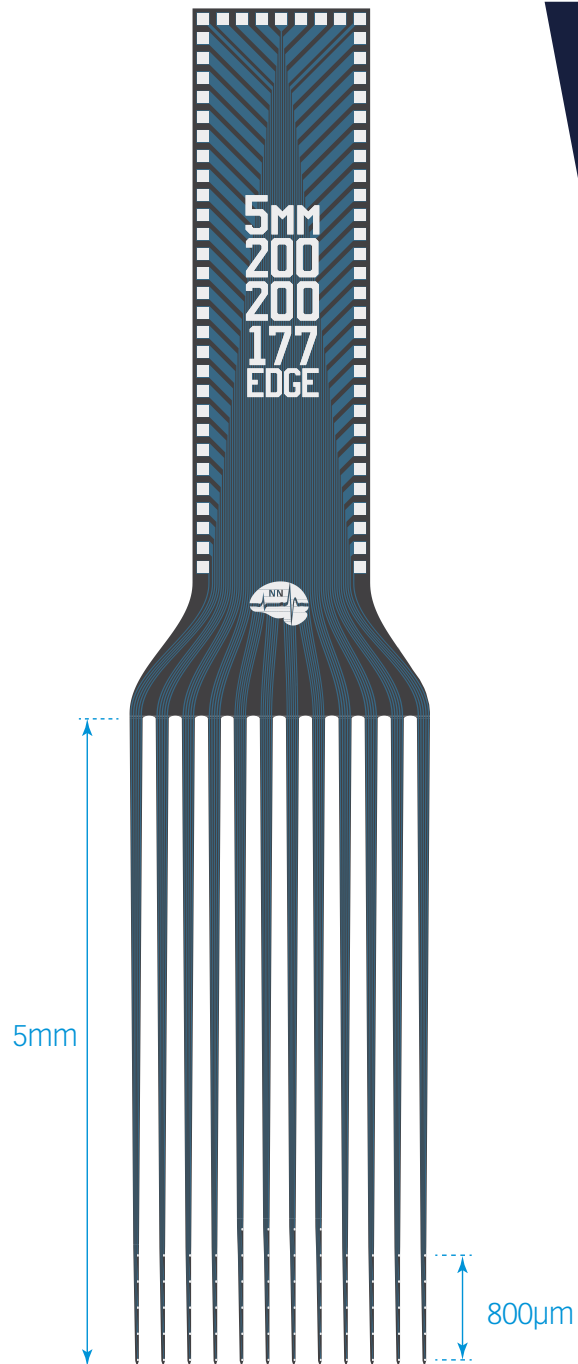

TIP DETAIL



available packages

ACUTE
A64

CHRONIC
H64_30mm
H64LP_30mm
HC64_30mm
HZ64_30mm
Z64
X3-64
X3-H64_30mm

OPTOGENETICS
OA64LP
OA64LP_v2
OH64LP (oDrive)
OXA64LP
(Optogenix)

MR-COMPATIBLE
MR_H64_30mm
MR_HC64_30mm

ACTIVUS
AV64
AVI64
AVH64
AVIH64

SEARAY
SEACM64

Note: For H-package 64 channel designs: Unless otherwise requested you will receive a probe with up to 2 irregular sites. If you require a perfect probe, please specify when ordering.

thickness

50 µm

A8x8-Edge-2mm-100-200-413

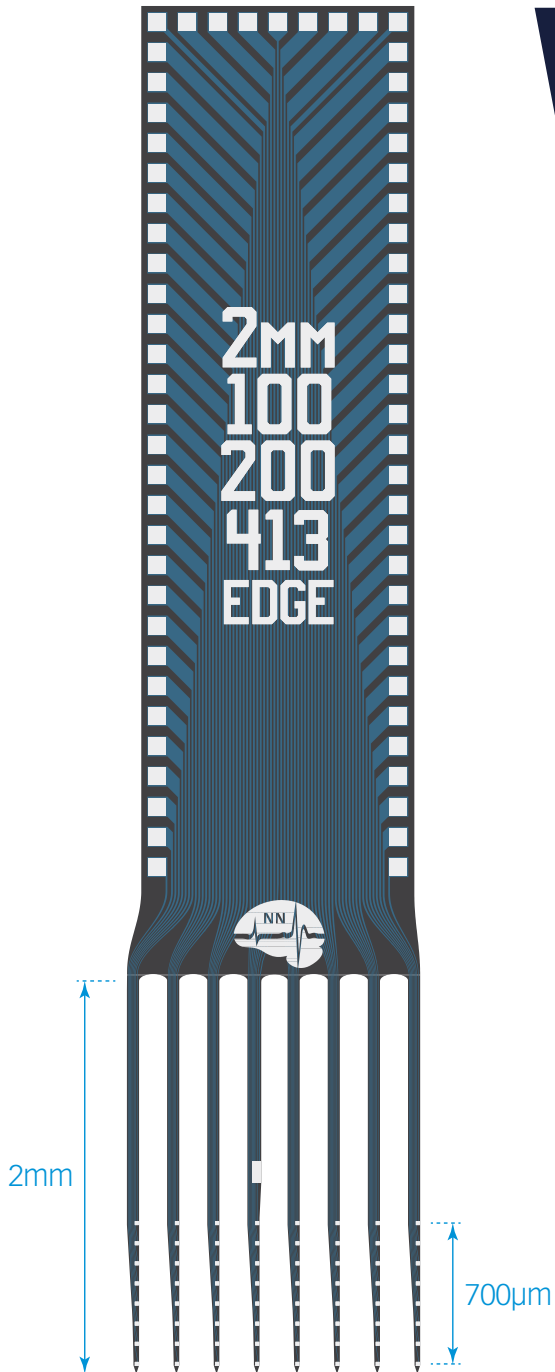

TIP DETAIL

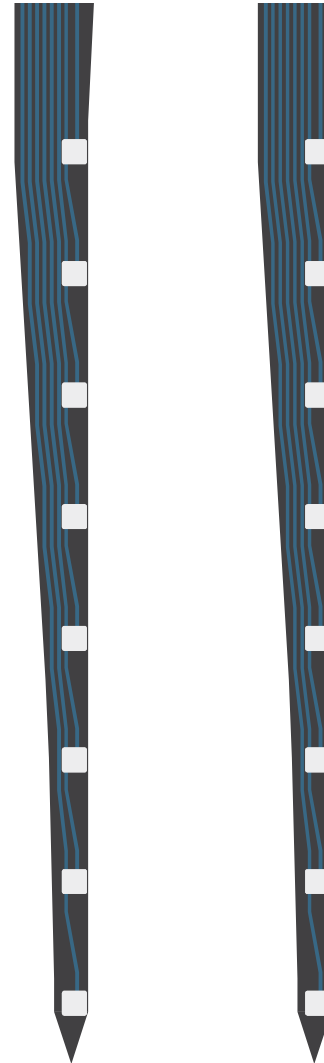

available packages

ACUTE
A64

CHRONIC
H64_30mm
H64LP_30mm
HC64_30mm
HZ64_30mm
Z64
X3-64
X3-H64_30mm

OPTOGENETICS
OA64LP
OA64LP_v2
OH64LP (oDrive)
OXA64LP
(Optogenix)

MR-COMPATIBLE
MR_H64_30mm
MR_HC64_30mm

ACTIVUS
AV64
AVI64
AVH64
AVIH64

SEARAY
SEACM64

Note: For H-package 64 channel designs: Unless otherwise requested you will receive a probe with up to 2 irregular sites. If you require a perfect probe, please specify when ordering.

thickness

50 µm

A8x8-5mm-200-200-177

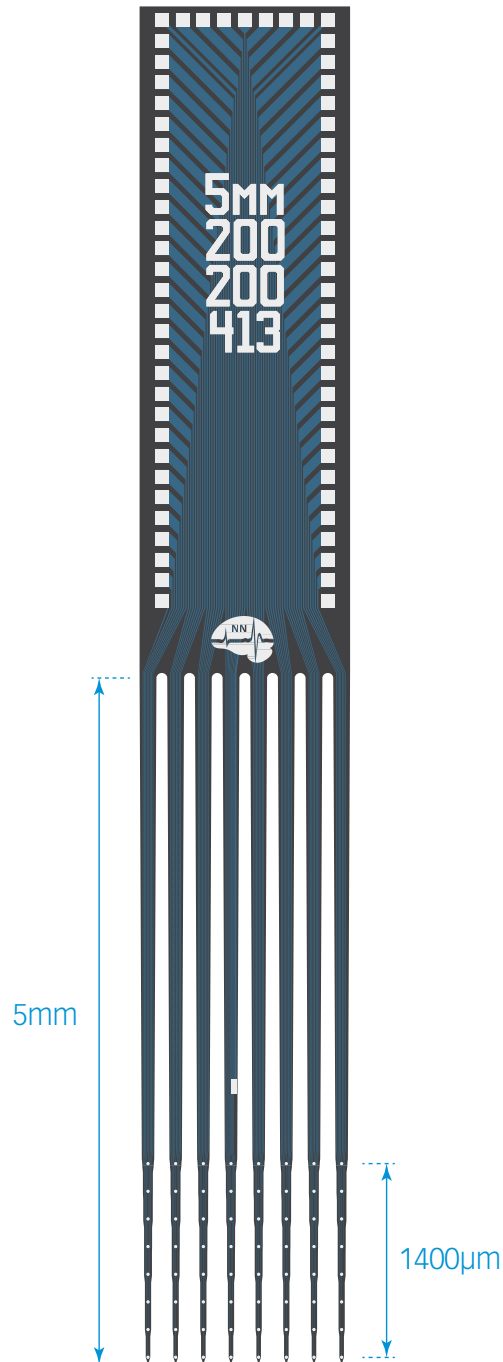

TIP DETAIL

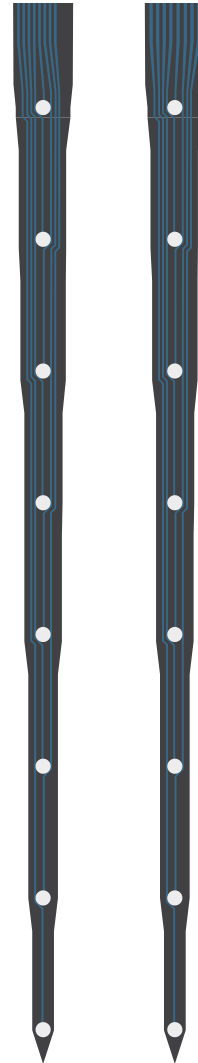

available packages

ACUTE
A64

CHRONIC
H64_30mm
H64LP_30mm
HC64_30mm
HZ64_30mm
Z64
X3-64
X3-H64_30mm

OPTOGENETICS
OA64LP
OA64LP_v2
OH64LP (oDrive)
OXA64LP
(Optogenix)

MR-COMPATIBLE
MR_H64_30mm
MR_HC64_30mm

ACTIVUS
AV64
AVI64
AVH64
AVIH64

SEARAY
SEACM64

Note: For H-package 64 channel designs: Unless otherwise requested you will receive a probe with up to 2 irregular sites. If you require a perfect probe, please specify when ordering.

thickness

15 µm

A8X8-5mm-200-200-413

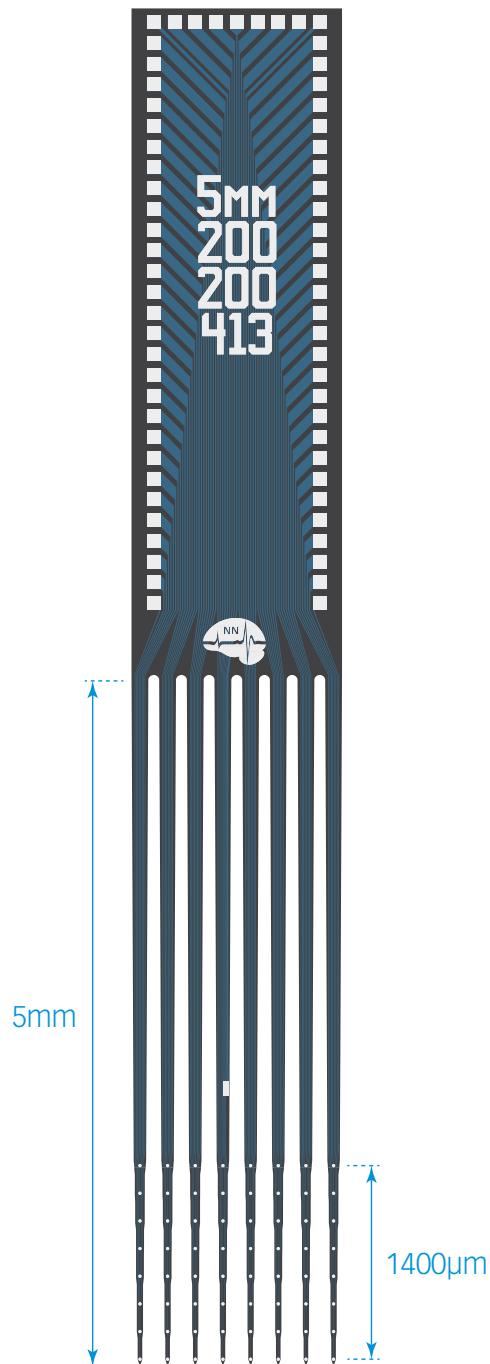

TIP DETAIL

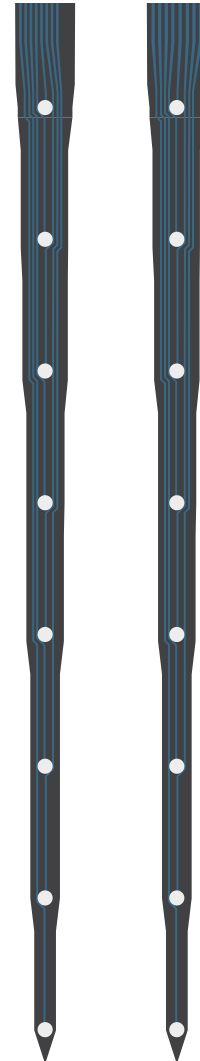

available packages

ACUTE
A64

CHRONIC
H64_30mm
H64LP_30mm
HC64_30mm
HZ64_30mm
Z64
X3-64
X3-H64_30mm

OPTOGENETICS
OA64LP
OA64LP_v2
OH64LP (oDrive)
OXA64LP
(Optogenix)

MR-COMPATIBLE
MR_H64_30mm
MR_HC64_30mm

ACTIVUS
AV64
AVI64
AVH64
AVIH64

SEARAY
SEACM64

Note: For H-package 64 channel designs: Unless otherwise requested you will receive a probe with up to 2 irregular sites. If you require a perfect probe, please specify when ordering.

thickness

15 and 50 μm

A8x8-5mm-200-200-703

available packages

ACUTE

A64

CHRONIC
H64_30mm
H64LP_30mm
HC64_30mm
HZ64_30mm
Z64
X3-64
X3-H64_30mm

OPTOGENETICS

OA64LP
OA64LP_v2
OH64LP (oDrive)
OXA64LP
(Optogenix)

MR-COMPATIBLE

MR_H64_30mm
MR_HC64_30mm

ACTIVUS

AV64
AVI64
AVH64
AVIH64

SEARAY

SEACM64

Note: For H-package 64 channel designs: Unless otherwise requested you will receive a probe with up to 2 irregular sites. If you require a perfect probe, please specify when ordering.

thickness

50 μ m

TIP DETAIL

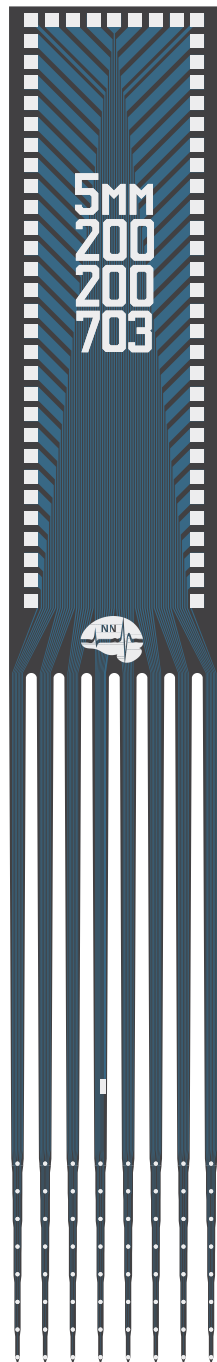
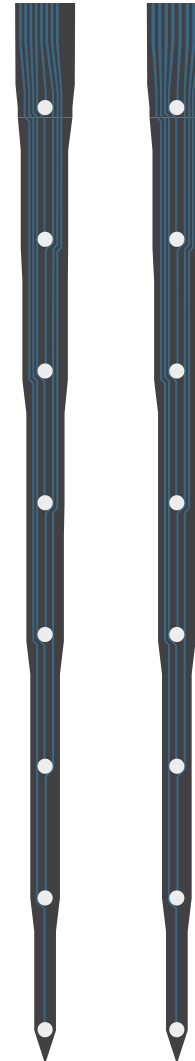

5mm

1400 μ m

A8x8-5mm-300-200-177

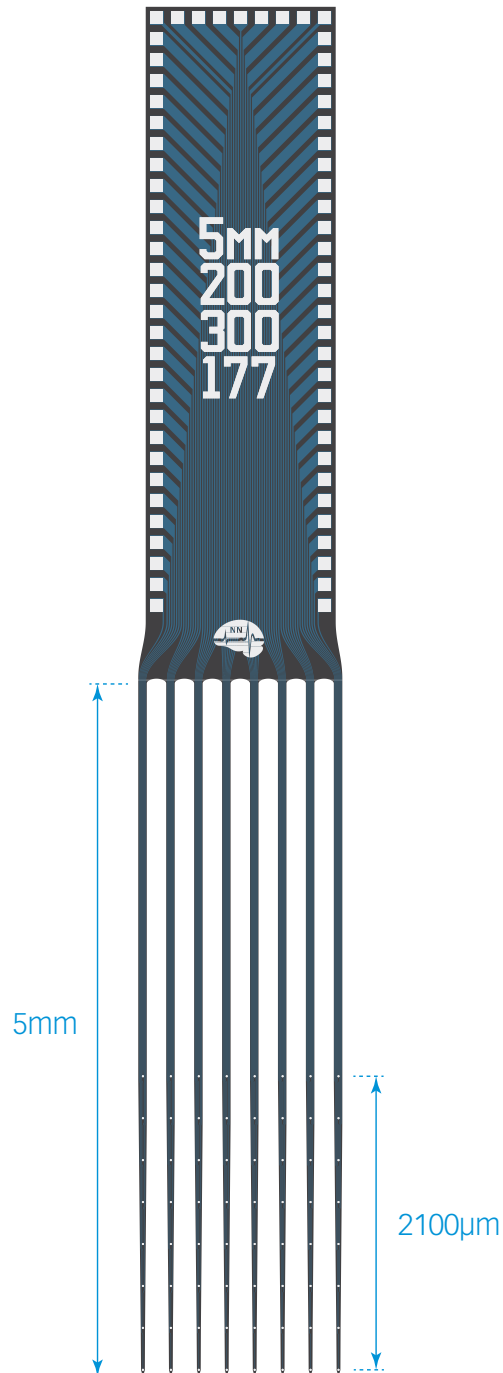

TIP DETAIL

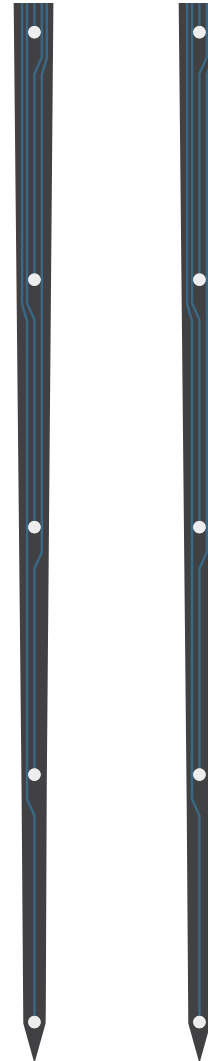

available packages

ACUTE A64

CHRONIC
H64_30mm
H64LP_30mm
HC64_30mm
HZ64_30mm
Z64
X3-64
X3-H64_30mm

OPTOGENETICS
OA64LP
OA64LP_v2
OH64LP (oDrive)
OXA64LP
(Optogenix)

MR-COMPATIBLE
MR_H64_30mm
MR_HC64_30mm

ACTIVUS
AV64
AVI64
AVH64
AVIH64

SEARAY
SEACM64

Note: For H-package 64 channel designs: Unless otherwise requested you will receive a probe with up to 2 irregular sites. If you require a perfect probe, please specify when ordering.

thickness

50 µm

A8x8-Edge-5mm-100-200-177

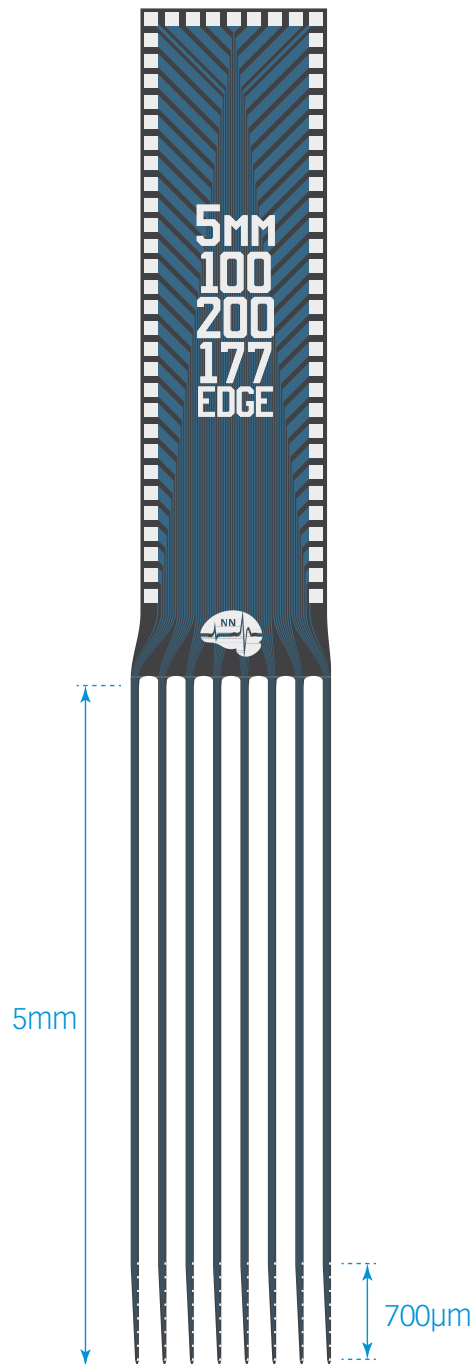

TIP DETAIL

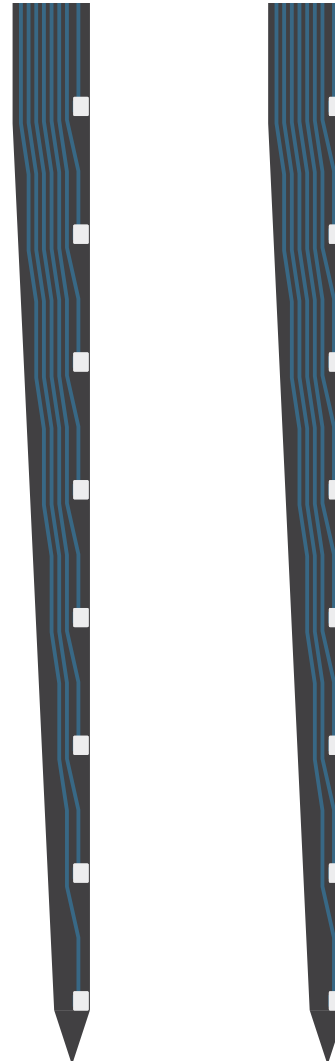

available packages

ACUTE
A64

CHRONIC
H64_30mm
H64LP_30mm
HC64_30mm
HZ64_30mm
Z64
X3-64
X3-H64_30mm

OPTOGENETICS
OA64LP
OA64LP_v2
OH64LP (oDrive)
OXA64LP
(Optogenix)

MR-COMPATIBLE
MR_H64_30mm
MR_HC64_30mm

ACTIVUS
AV64
AVI64
AVH64
AVIH64

SEARAY
SEACM64

Note: For H-package 64 channel designs: Unless otherwise requested you will receive a probe with up to 2 irregular sites. If you require a perfect probe, please specify when ordering.

thickness

15 µm

A8x8-Edge-5mm-50-150-177

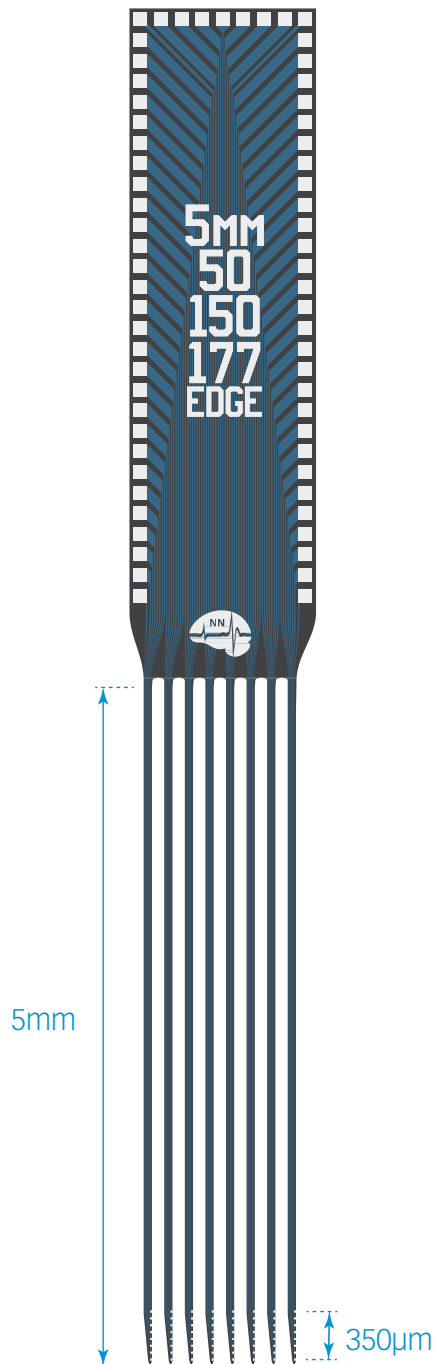

TIP DETAIL

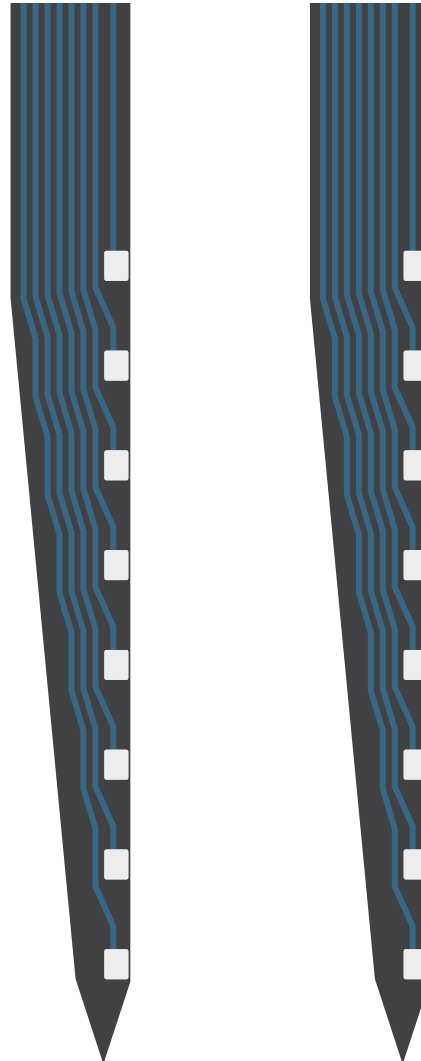

available packages

ACUTE

A64

CHRONIC
H64_30mm
H64LP_30mm
HC64_30mm
HZ64_30mm
Z64
X3-64
X3-H64_30mm

OPTOGENETICS

OA64LP
OA64LP_v2
OH64LP (oDrive)
OXA64LP
(Optogenix)

MR-COMPATIBLE

MR_H64_30mm
MR_HC64_30mm

ACTIVUS

AV64
AVI64
AVH64
AVIH64

SEARAY

SEACM64

Note: For H-package 64 channel designs: Unless otherwise requested you will receive a probe with up to 2 irregular sites. If you require a perfect probe, please specify when ordering.

thickness

15 µm

Buzsaki64

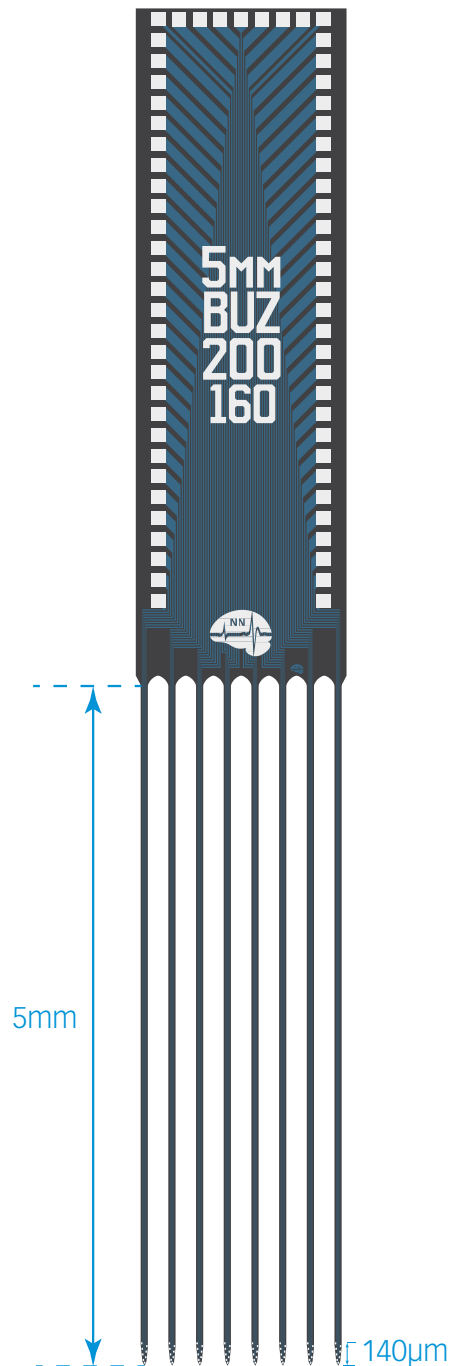

TIP DETAIL

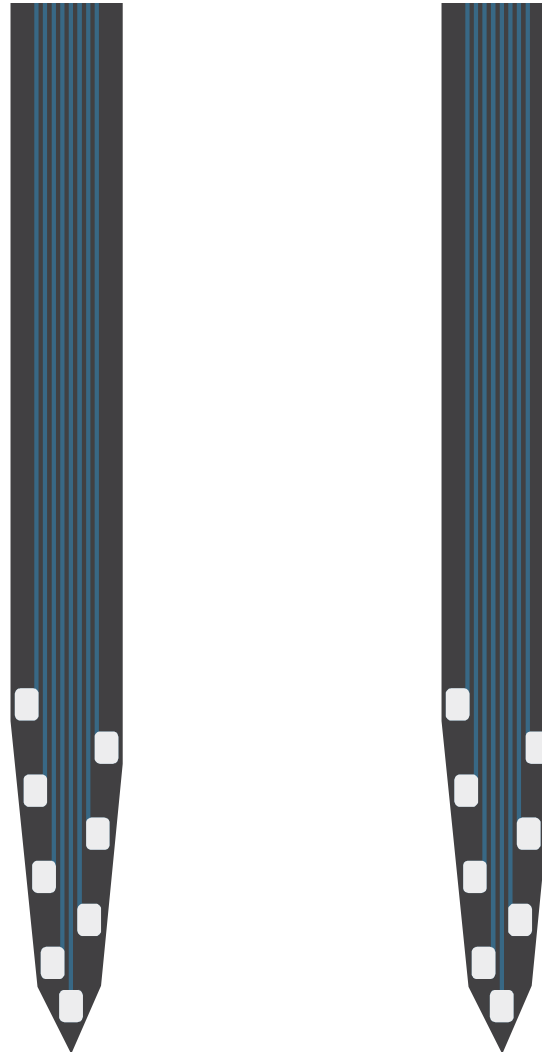

available packages

ACUTE A64

CHRONIC
H64_30mm
H64LP_30mm
HC64_30mm
HZ64_30mm
Z64
X3-64
X3-H64_30mm

OPTOGENETICS

OA64LP
OA64LP_v2
OH64LP (oDrive)
OXA64LP
(Optogenix)

MR-COMPATIBLE

MR_H64_30mm
MR_HC64_30mm

ACTIVUS

AV64
AVI64
AVH64
AVIH64

SEARAY SEACM64

Note: For H-package 64 channel designs: Unless otherwise requested you will receive a probe with up to 2 irregular sites. If you require a perfect probe, please specify when ordering.

thickness

15 and 50 µm

Buzsaki64sp

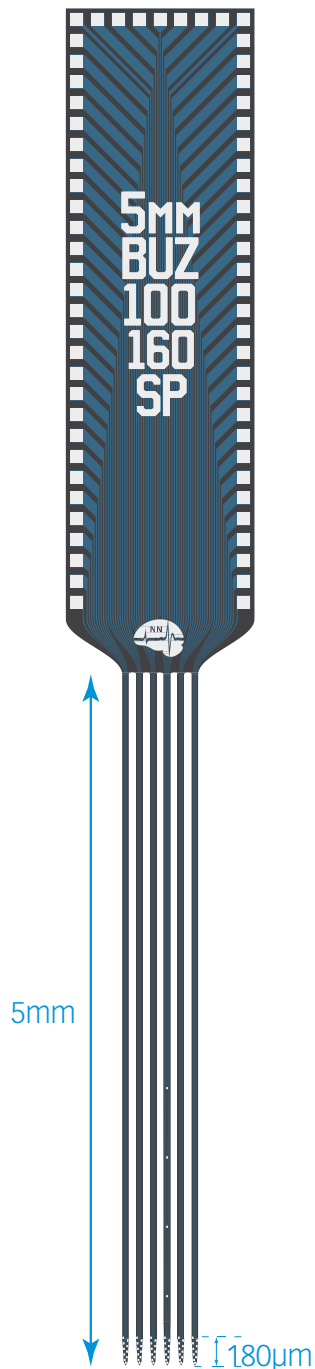

TIP DETAIL

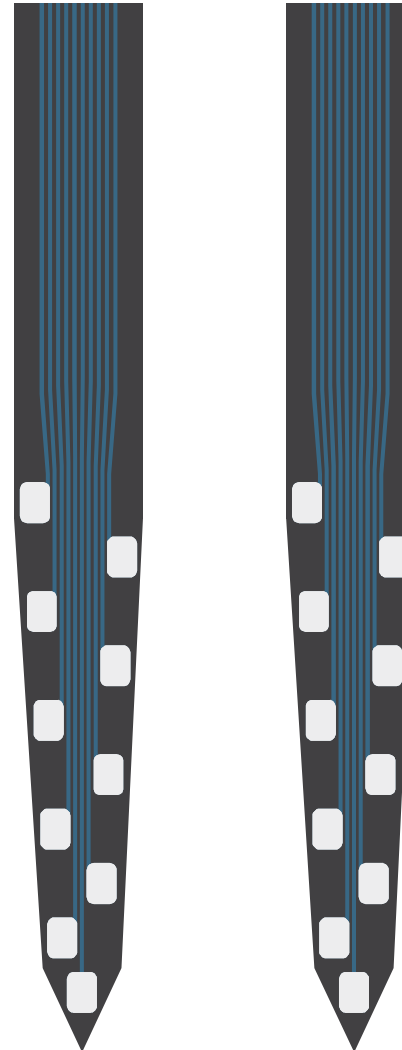

available packages

ACUTE
A64

CHRONIC
H64_30mm
H64LP_30mm
HC64_30mm
HZ64_30mm
Z64
X3-64
X3-H64_30mm

OPTOGENETICS
OA64LP
OA64LP_v2
OH64LP (oDrive)
OXA64LP
(Optogenix)

MR-COMPATIBLE
MR_H64_30mm
MR_HC64_30mm

ACTIVUS
AV64
AVI64
AVH64
AVIH64

SEARAY
SEACM64

Note: For H-package 64 channel designs: Unless otherwise requested you will receive a probe with up to 2 irregular sites. If you require a perfect probe, please specify when ordering.

thickness

15 µm

Buz64_sp_100

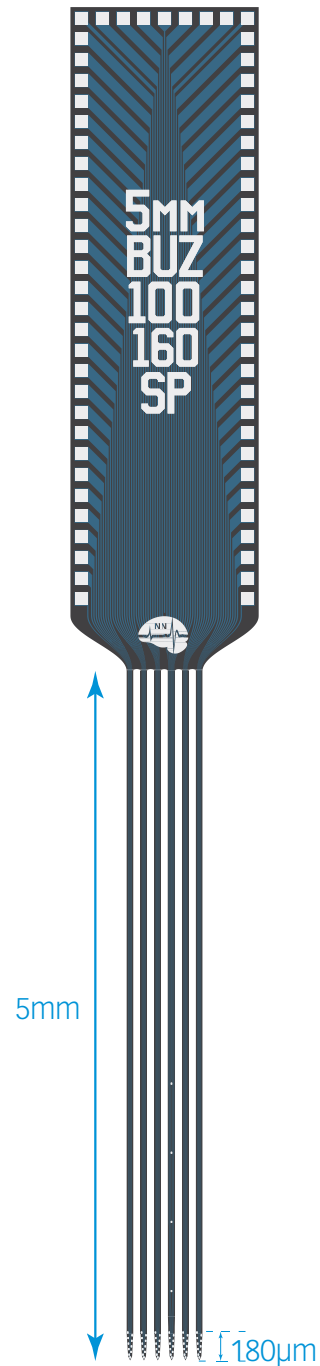

TIP DETAIL

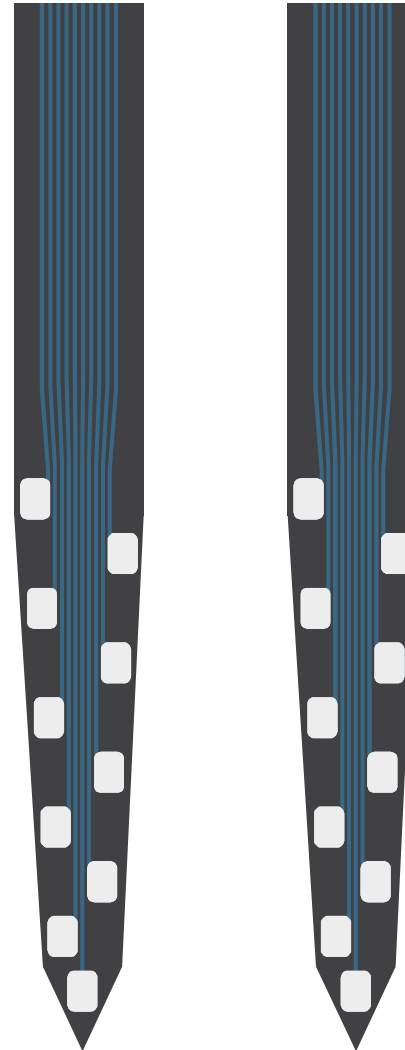

available packages

ACUTE
A64

CHRONIC
H64_30mm
H64LP_30mm
HC64_30mm
HZ64_30mm
Z64
X3-64
X3-H64_30mm

OPTOGENETICS
OA64LP
OA64LP_v2
OH64LP (oDrive)
OXA64LP
(Optogenix)

MR-COMPATIBLE
MR_H64_30mm
MR_HC64_30mm

ACTIVUS
AV64
AVI64
AVH64
AVIH64
SEARAY
SEACM64

Note: For H-package 64 channel designs: Unless otherwise requested you will receive a probe with up to 2 irregular sites. If you require a perfect probe, please specify when ordering.

thickness

15 µm

A8x2-tet-7mm-150-200-121

available packages

ACUTE A64

CHRONIC
H64_30mm
H64LP_30mm
HC64_30mm
HZ64_30mm
Z64
X3-64
X3-H64_30mm

OPTOGENETICS
OA64LP
OA64LP_v2
OH64LP (oDrive)
OXA64LP
(Optogenix)

MR-COMPATIBLE
MR_H64_30mm
MR_HC64_30mm

ACTIVUS
AV64
AVI64
AVH64
AVIH64

SEARAY
SEACM64

Note: For H-package 64 channel designs: Unless otherwise requested you will receive a probe with up to 2 irregular sites. If you require a perfect probe, please specify when ordering.

thickness

15 μm

TIP DETAIL

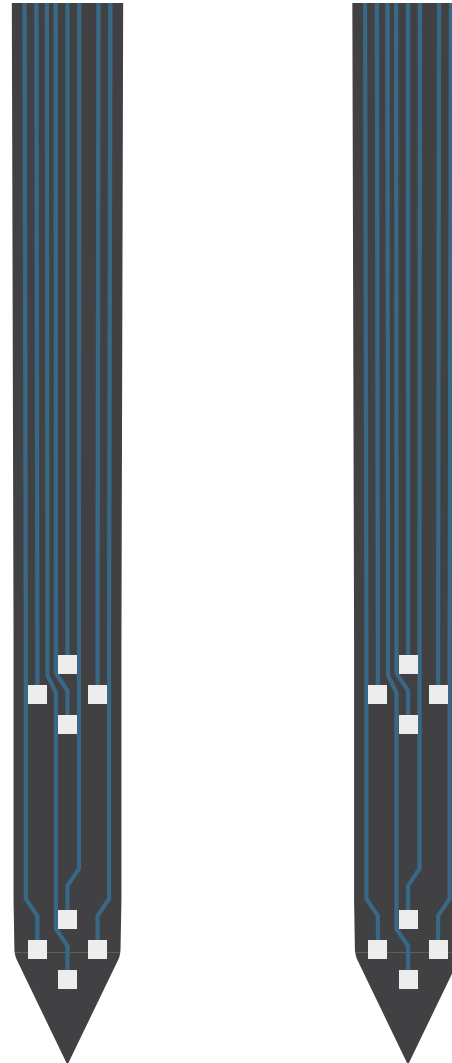
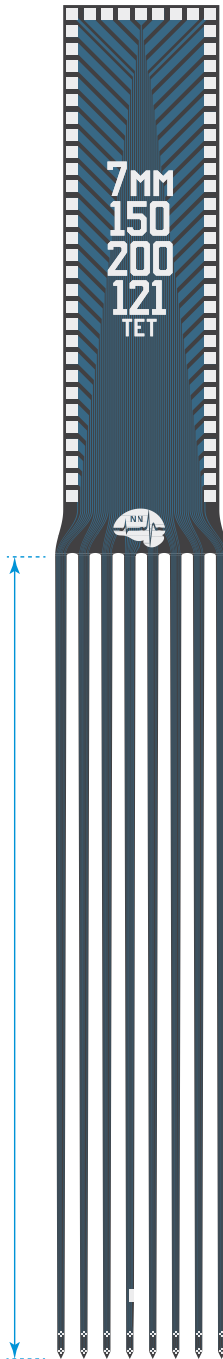

7mm

ISO64-4x-tet-lin-7.5mm

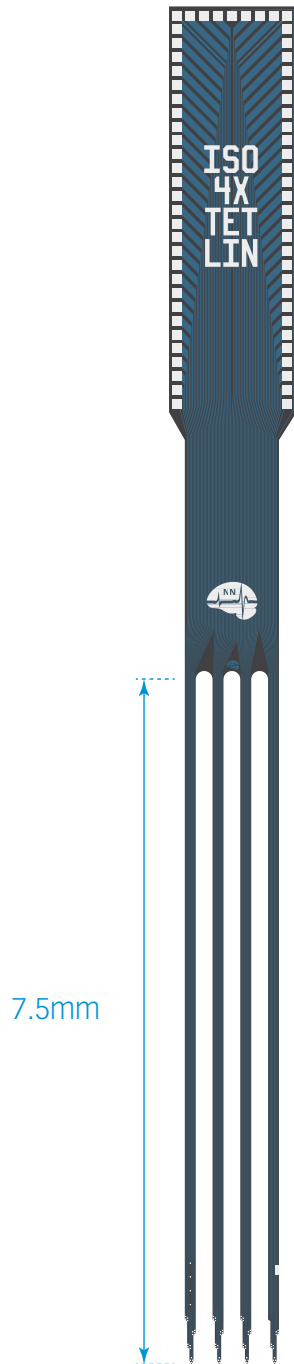

TIP DETAIL

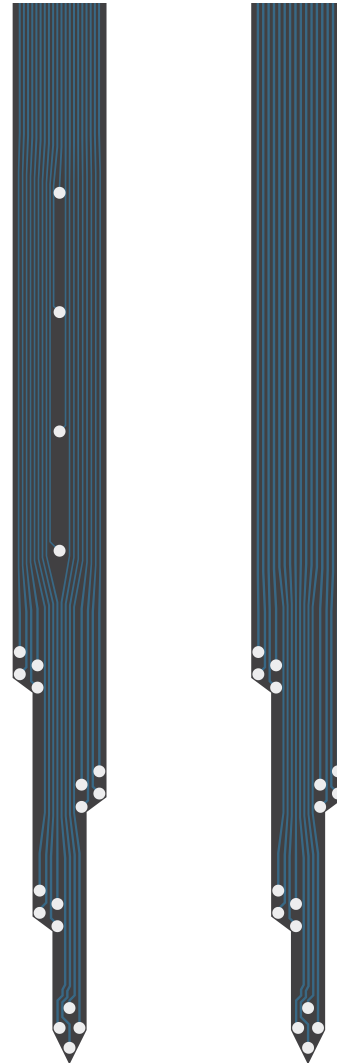

available packages

ACUTE A64

CHRONIC
H64_30mm
H64LP_30mm
HC64_30mm
HZ64_30mm
Z64
X3-64
X3-H64_30mm

OPTOGENETICS
OA64LP
OA64LP_v2
OH64LP (oDrive)
OXA64LP
(Optogenix)

MR-COMPATIBLE
MR_H64_30mm
MR_HC64_30mm

ACTIVUS
AV64
AVI64
AVH64
AVIH64
SEARAY
SEACM64

Note: For H-package 64 channel designs: Unless otherwise requested you will receive a probe with up to 2 irregular sites. If you require a perfect probe, please specify when ordering.

thickness

15 μ m

A8x8/4mm-500-gap-1250-1250/177

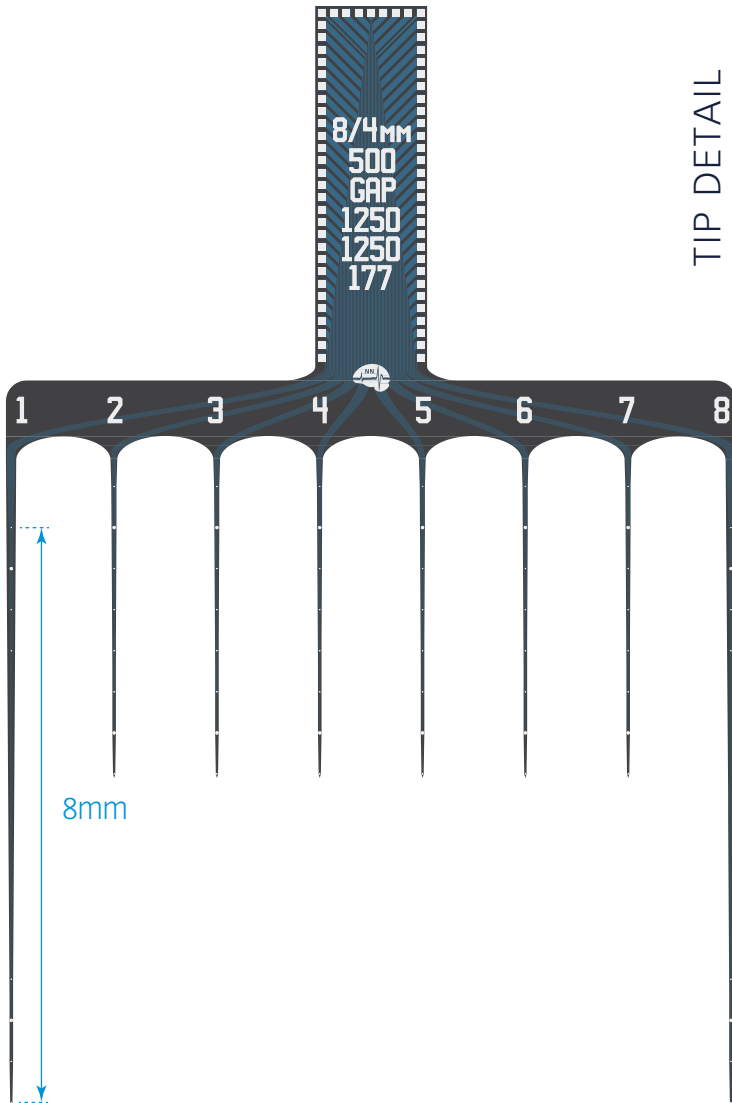

TIP DETAIL

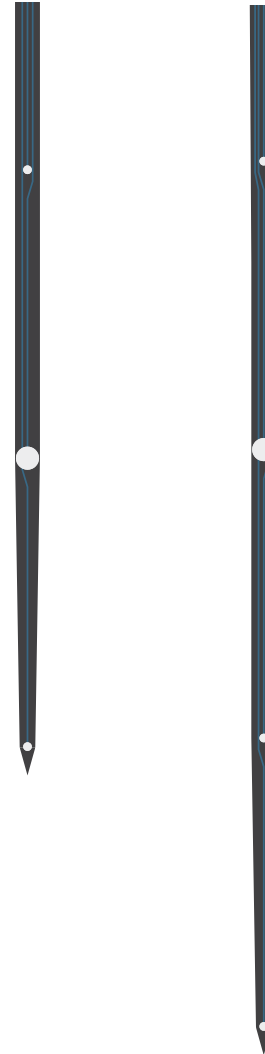

available packages

ACUTE A64

CHRONIC
H64_30mm
H64LP_30mm
HC64_30mm
HZ64_30mm
Z64
X3-64
X3-H64_30mm

OPTOGENETICS

OA64LP
OA64LP_v2
OH64LP (oDrive)
OXA64LP
(Optogenix)

MR-COMPATIBLE

MR_H64_30mm
MR_HC64_30mm

ACTIVUS

AV64
AVI64
AVH64
AVIH64

SEARAY

SEACM64

Note: For H-package 64 channel designs: Unless otherwise requested you will receive a probe with up to 2 irregular sites. If you require a perfect probe, please specify when ordering.

thickness

15 μ m

A8x8-10mm-200-200-177

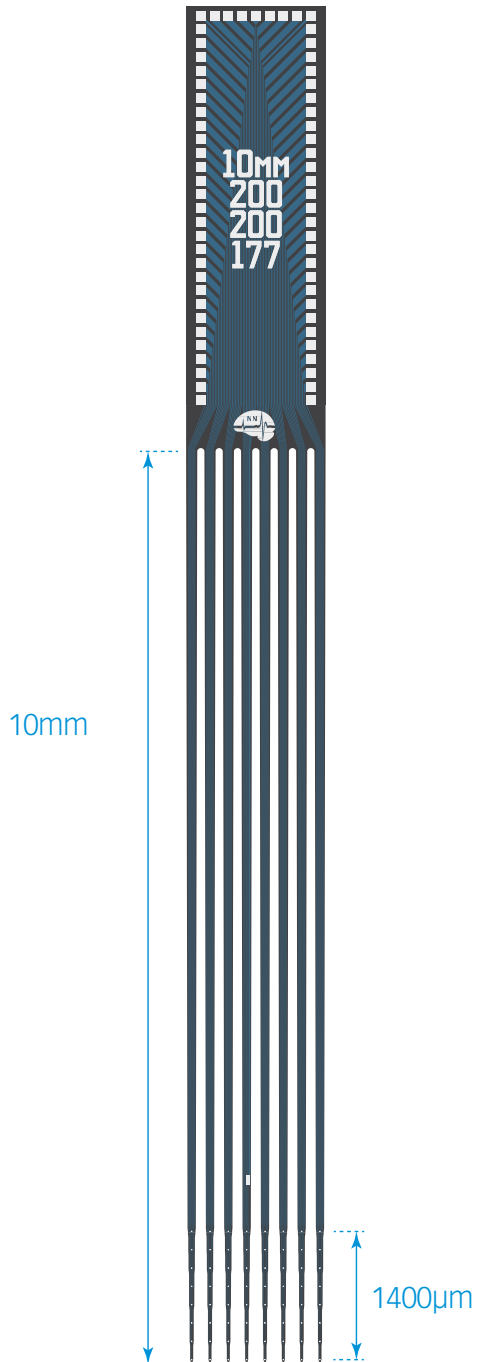

TIP DETAIL

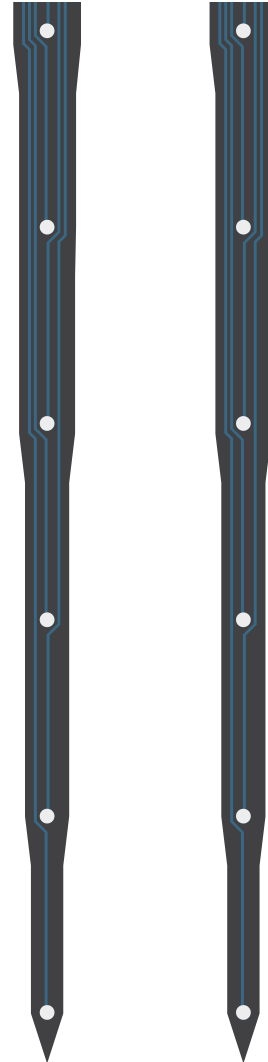

available packages

ACUTE
A64

CHRONIC
H64_30mm
H64LP_30mm
HC64_30mm
HZ64_30mm
Z64
X3-64
X3-H64_30mm

OPTOGENETICS
OA64LP
OA64LP_v2
OH64LP (oDrive)
OXA64LP
(Optogenix)

MR-COMPATIBLE
MR_H64_30mm
MR_HC64_30mm

ACTIVUS
AV64
AVI64
AVH64
AVIH64

SEARAY
SEACM64

Note: For H-package 64 channel designs: Unless otherwise requested you will receive a probe with up to 2 irregular sites. If you require a perfect probe, please specify when ordering.

thickness

50 µm

A8x8-10mm-200-200-413

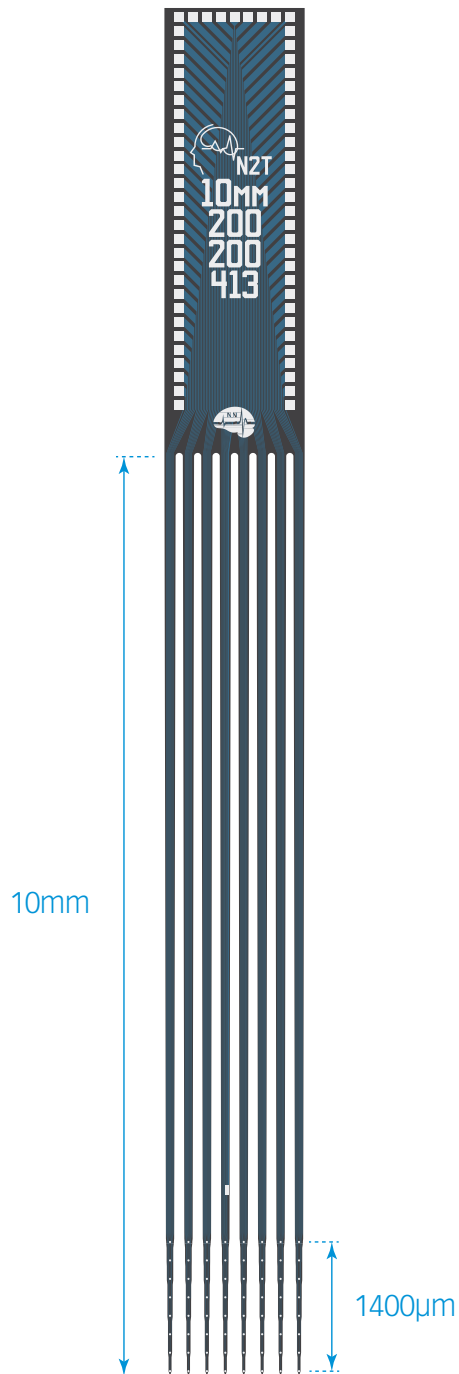

TIP DETAIL

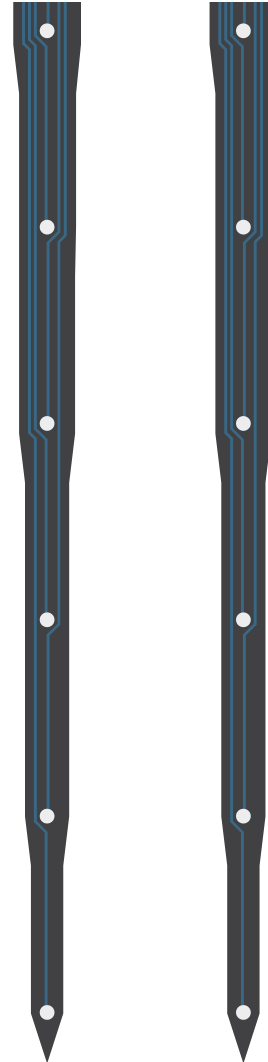

available packages

ACUTE
A64

CHRONIC
H64_30mm
H64LP_30mm
HC64_30mm
HZ64_30mm
Z64
X3-64
X3-H64_30mm

OPTOGENETICS
OA64LP
OA64LP_v2
OH64LP (oDrive)
OXA64LP
(Optogenix)

MR-COMPATIBLE
MR_H64_30mm
MR_HC64_30mm

ACTIVUS
AV64
AVI64
AVH64
AVIH64

SEARAY
SEACM64

Note: For H-package 64 channel designs: Unless otherwise requested you will receive a probe with up to 2 irregular sites. If you require a perfect probe, please specify when ordering.

thickness

50 µm

A8x8-10mm-200-200-703

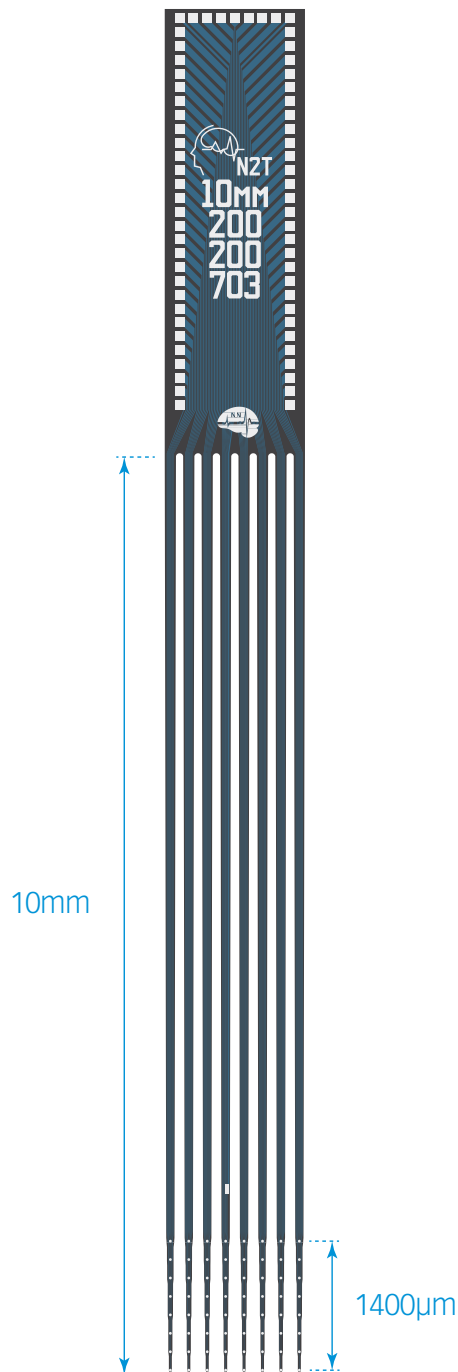

TIP DETAIL

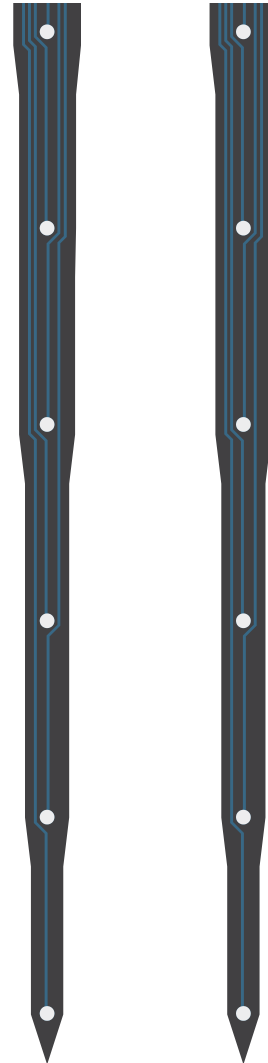

available packages

ACUTE A64

CHRONIC
H64_30mm
H64LP_30mm
HC64_30mm
HZ64_30mm
Z64
X3-64
X3-H64_30mm

OPTOGENETICS
OA64LP
OA64LP_v2
OH64LP (oDrive)
OXA64LP
(Optogenix)

MR-COMPATIBLE
MR_H64_30mm
MR_HC64_30mm

ACTIVUS
AV64
AVI64
AVH64
AVIH64

SEARAY
SEACM64

Note: For H-package 64 channel designs: Unless otherwise requested you will receive a probe with up to 2 irregular sites. If you require a perfect probe, please specify when ordering.

thickness

50 µm

Buzsaki64L

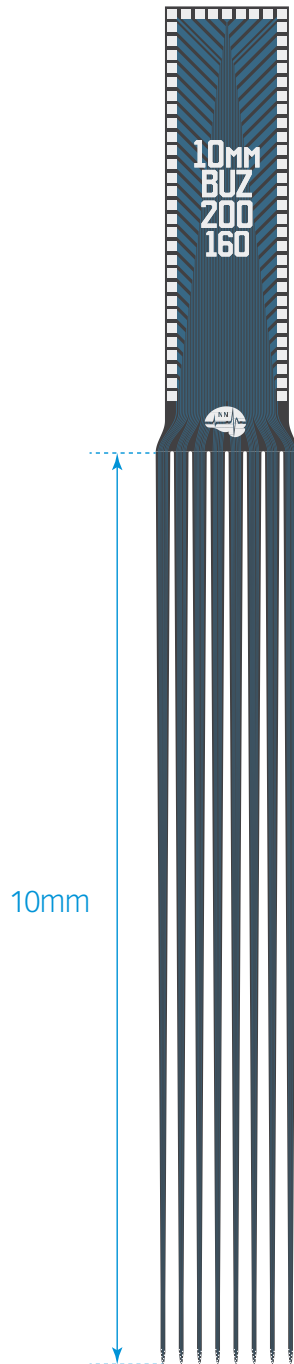

TIP DETAIL

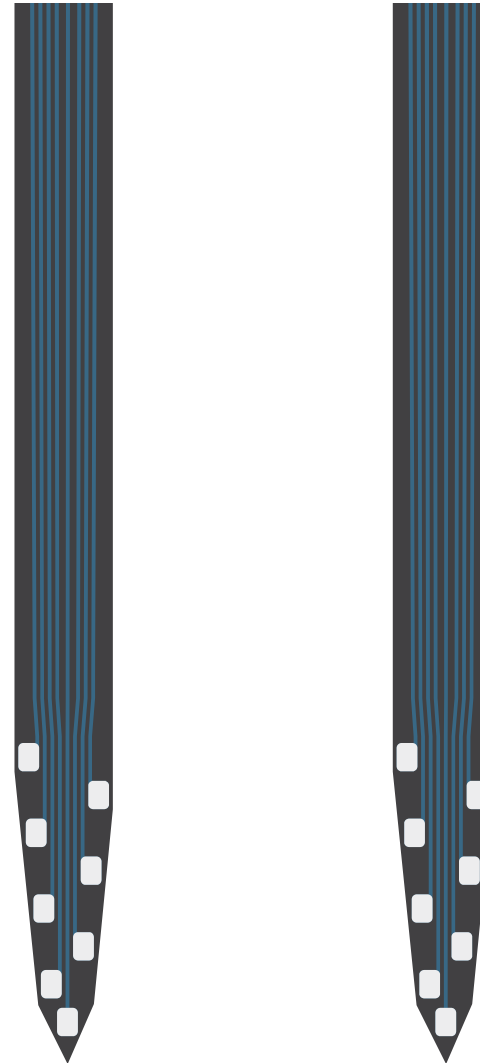

available packages

ACUTE A64

CHRONIC
H64_30mm
H64LP_30mm
HC64_30mm
HZ64_30mm
Z64
X3-64
X3-H64_30mm

OPTOGENETICS
OA64LP
OA64LP_v2
OH64LP (oDrive)
OXA64LP
(Optogenix)

MR-COMPATIBLE
MR_H64_30mm
MR_HC64_30mm

ACTIVUS
AV64
AVI64
AVH64
AVIH64

SEARAY
SEACM64

Note: For H-package 64 channel designs: Unless otherwise requested you will receive a probe with up to 2 irregular sites. If you require a perfect probe, please specify when ordering.

thickness

15 and 50 μm

Buzsaki64spL

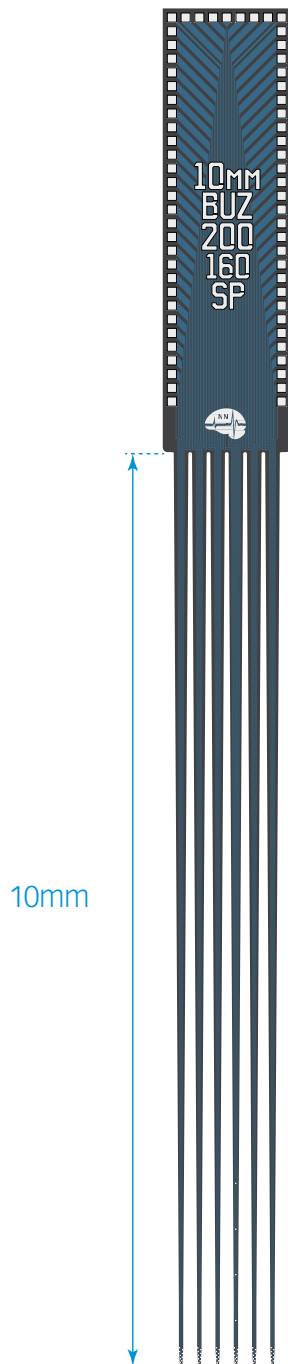

TIP DETAIL

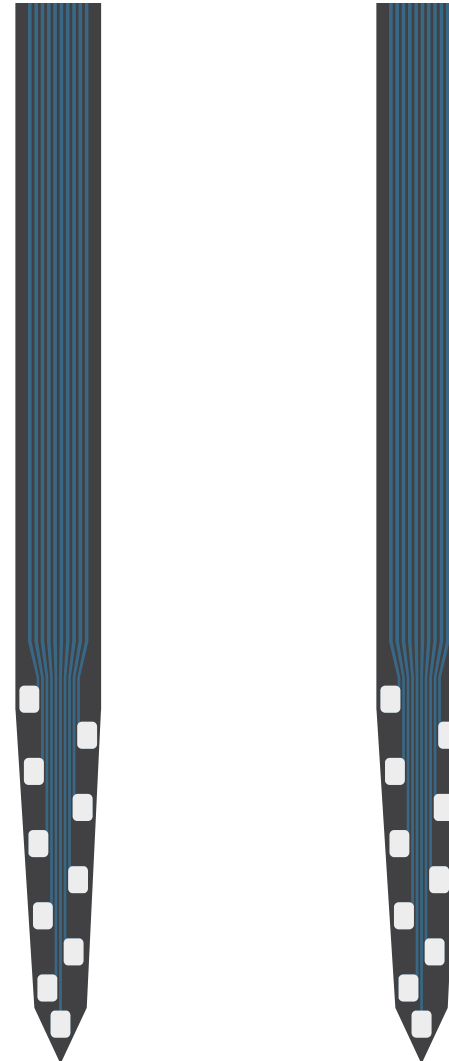

available packages

ACUTE

A64

CHRONIC
H64_30mm
H64LP_30mm
HC64_30mm
HZ64_30mm
Z64
X3-64
X3-H64_30mm

OPTOGENETICS

OA64LP
OA64LP_v2
OH64LP (oDrive)
OXA64LP
(Optogenix)

MR-COMPATIBLE

MR_H64_30mm
MR_HC64_30mm

ACTIVUS

AV64
AVI64
AVH64
AVIH64

SEARAY

SEACM64

Note: For H-package 64 channel designs: Unless otherwise requested you will receive a probe with up to 2 irregular sites. If you require a perfect probe, please specify when ordering.

thickness

50 μ m

Buzsaki64sp (15mm)

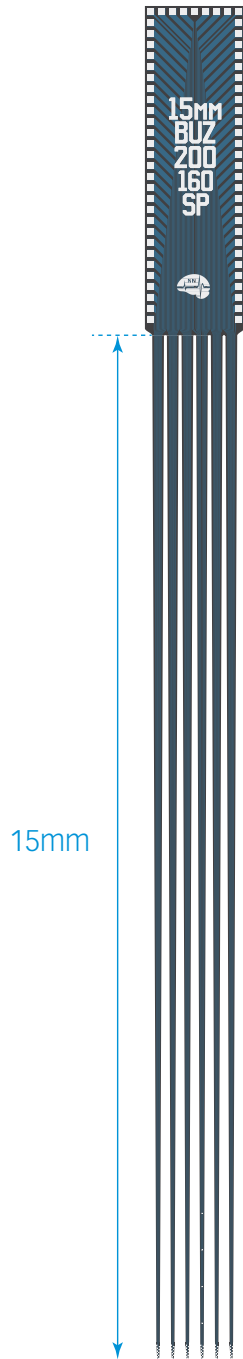

TIP DETAIL

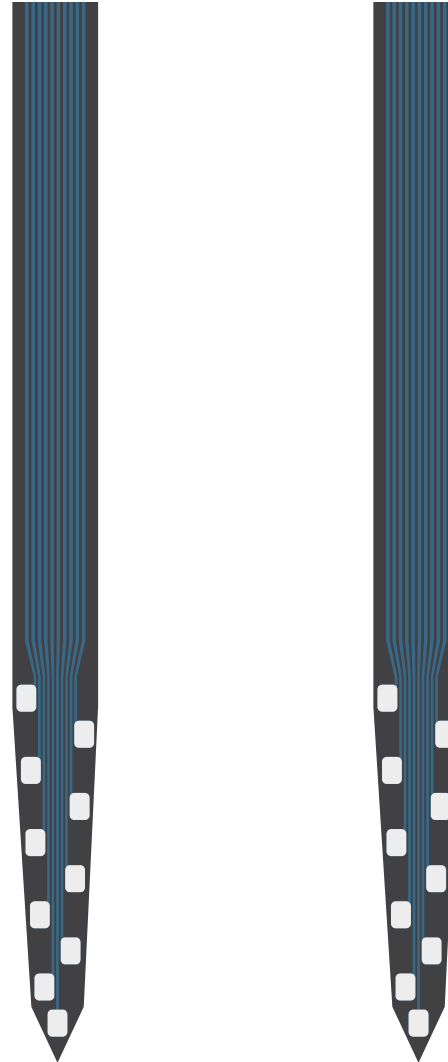

available packages

ACUTE
A64

CHRONIC
H64_30mm
H64LP_30mm
HC64_30mm
HZ64_30mm
Z64
X3-64
X3-H64_30mm

OPTOGENETICS
OA64LP
OA64LP_v2
OH64LP (oDrive)
OXA64LP
(Optogenix)

MR-COMPATIBLE
MR_H64_30mm
MR_HC64_30mm

ACTIVUS
AV64
AVI64
AVH64
AVIH64

SEARAY
SEACM64

Note: For H-package 64 channel designs: Unless otherwise requested you will receive a probe with up to 2 irregular sites. If you require a perfect probe, please specify when ordering.

thickness

15 μ m