

Made to measure

OPERATING INSTRUCTIONS AND SYSTEM DESCRIPTION FOR THE

TURBO TEC-03X

TWO ELECTRODE CLAMP SYSTEM



VERSION 4.8

npi 2013

npi electronic GmbH, Bauhofring 16, D-71732 Tamm, Germany
Phone +49 (0)7141-9730230; Fax: +49 (0)7141-9730240
support@npielelectronic.com; <http://www.npielectronic.com>

Table of Contents

About this Manual	4
1. Safety Regulations.....	6
2. Introduction	7
3. TURBO TEC-03X Components.....	8
4. TURBO TEC-03X System.....	8
4.1. System Description.....	8
Potential Measurement	9
Current Injection and Measurement	10
Current Clamp Mode (CC).....	10
Voltage Clamp Mode (VC)	10
Control Circuit in VC	11
Control Modes of VC	11
Improvement of the Control Properties	12
4.2. Description of the Front Panel.....	13
4.3. Description of the Rear Panel.....	21
Grounding.....	22
TEC-03X-CW.....	23
5. Headstages.....	25
5.1. Potential Headstage	25
Headstage Elements.....	25
5.2. Current Headstage	26
Options	28
6. Setting up the TEC-03X	29
7. Passive Cell Model.....	30
7.1. Cell Model Description	31
7.2. Connections and Operation	32
Checking the Configuration with the Cell Model	32
8. Test and Tuning Procedures	33
8.1. Current Headstage Bias Current Adjustment	33
8.2. Offset Compensation	35
Potential Electrode.....	35
Current Electrode.....	35
8.3. Electrode Resistance Test.....	35
Potential Electrode.....	36
Current Electrode.....	36
8.4. Capacity Compensation.....	36
8.5. Testing Operation Modes	37
Current Clamp	37
Voltage Clamp.....	37
8.6. Tuning the VC mode	38
General Considerations	38
Tuning Procedure	40
8.7. Installing and Testing a Data Acquisition Board from National Instruments.....	42
Basic Test of INT-20X and Data Acquisition board.....	42
Test using a Breakout Box	43
Test without a Breakout Box.....	45
9. Positioning of Electrodes.....	46
10. Sample Experiment	47
11. Trouble Shooting.....	49

12. Appendix	50
12.1. Theory of Operation	50
12.2. Tuning Procedures for VC Controllers.....	52
Practical Implications	52
12.3. Speed of Response and Linearity of the Capacitive Transients	55
13. References	58
14. TURBO TEC-03X Specifications – Technical Data.....	69
Index	72

About this Manual

This manual should help to setup and use the TURBO TEC-03X system correctly and to perform reliable experiments.

The manual is divided into 13 chapters. Chapter 1 contains important information about safety regulations. Chapter 2 gives a brief introduction to the amplifier. Chapter 3 lists the components and (optional) accessories of the TEC-03X. In chapter 4 a general description of the TEC-03X system is given and the control elements of front- and rear panel are explained. Chapter 5 is about the headstages and in chapter 6 the basic connections are described. Chapter 7 deals with the passive cell model and its connection to the amplifier. Several test and tuning procedures are outlined in chapter 8 including hints for optimizing the clamp. Chapter 9 shows how to optimize the clamp properties by correct electrode positioning and chapter 10 describes a basic voltage clamp experiment. Chapter 11 gives hints in case of trouble and chapter 12 deals with theoretical aspects of closed loop circuits, voltage clamp control and optimization methods. Chapter 13 contains references and technical data are listed in chapter 14.

If you are not familiar with the use of instruments for two electrode voltage clamping of cells please read the manual completely. The experienced user should read at least chapters 4, 5, 8 and 12.

Important: Please read chapter 1 carefully! It contains general information about safety regulations and how to handle highly sensitive electronic instruments.

Signs and conventions

In this manual all elements of the front panel are written in capital letters as they appear on the front panel.

System components that are shipped in the standard configuration are marked with ✓, optional components with ⇄. In some chapters the user is guided step by step through a certain procedure. These steps are marked with □.

Important information, hints and special precautions are highlighted in gray.

Abbreviations

τ_{Cm} :	time constant of the cell membrane
Ai:	analog input
BW:	bandwidth
C _{EL} :	current electrode
C _m :	cell membrane capacity
DAC:	analog output
Do:	digital output
GND:	ground
I _{max} :	maximal current
K:	proportional gain
P _{EL} :	potential electrode
P _{PEL} :	potential at the potential electrode
P _{REF} :	potential at the reference electrode
R _{CEL} :	current electrode resistance
R _m :	cell membrane resistance

- R_{PEL}: potential electrode resistance
- R_{REF}: reference electrode resistance
- R_S: series resistance
- T_e: “equivalent” time constant
- T_{el}: time constant of the current electrode
- T_i: “small” time constant
- T_m: “large time constant
- T_r: time until the membrane potential reaches 100% of the command pulse for the first time
- T_s: time to reach a steady state within a tolerance of 2%

1. Safety Regulations

VERY IMPORTANT: Instruments and components supplied by npi electronic are **NOT** intended for clinical use or medical purposes (e.g. for diagnosis or treatment of humans), or for any other life-supporting system. npi electronic disclaims any warranties for such purpose. Equipment supplied by npi electronic must be operated only by selected, trained and adequately instructed personnel. For details please consult the **GENERAL TERMS OF DELIVERY AND CONDITIONS OF BUSINESS** of npi electronic, D-71732 Tamm, Germany.

- 1) **GENERAL:** This system is designed for use in scientific laboratories and should be operated by trained staff only. General safety regulations for operating electrical devices should be followed.
- 2) **AC MAINS CONNECTION:** While working with the npi systems, always adhere to the appropriate safety measures for handling electronic devices. Before using any device please read manuals and instructions carefully.
The device is to be operated only at 115/230 V 60/50 Hz AC. Please check for appropriate line voltage before connecting any system to mains.
Always use a three-wire line cord and a mains power-plug with a protection contact connected to ground (protective earth).
Before opening the cabinet, unplug the instrument.
Unplug the instrument when replacing the fuse or changing line voltage. Replace fuse only with an appropriate specified type.
- 3) **STATIC ELECTRICITY:** Electronic equipment is sensitive to static discharges. Some devices such as sensor inputs are equipped with very sensitive FET amplifiers, which can be damaged by electrostatic charge and must therefore be handled with care. Electrostatic discharges can be avoided by touching a grounded metal surface when changing or adjusting sensors. **Always turn power off when adding or removing modules, connecting or disconnecting sensors, headstages or other components from the instrument or 19" cabinet.**
- 4) **TEMPERATURE DRIFT / WARM-UP TIME:** All analog electronic systems are sensitive to temperature changes. Therefore, all electronic instruments containing analog circuits should be used only in a warmed-up condition (i.e. after internal temperature has reached steady-state values). In most cases a warm-up period of 20-30 minutes is sufficient.
- 5) **CURRENT INJECTION HIGH VOLTAGE HEADSTAGE** The current injection headstage has a ± 150 V output compliance. In addition, some TEC headstages are equipped with a driven shield electrode connector. After turning on the instrument do not touch the interior contact and the shield of the electrode plug and of the cable that is connected to this plug. **In addition, it is extremely important that the instrument is turned off when changing or adjusting the electrodes.**
- 6) **HANDLING:** Please protect the device from moisture, heat, radiation and corrosive chemicals.

2. Introduction

This instruction manual describes the most important functions and operation modes of the TURBO TEC-03X Voltage/Current Clamp amplifier. A short introduction to the theory and practice of the voltage clamp and current clamp technique is also included, as far as it is necessary for understanding the operation of this instrument. Many books and articles are available on these techniques. A selection of this literature is given at the end of this manual (see chapter 13).

The TURBO TEC-03X is an accurate and extremely fast voltage and current clamp (V/C) amplifier for studying large membrane currents. It is based on the standard two electrode approach and is an ideal system for recording from oocytes.

A significant improvement over other two electrode clamp amplifiers is that the TURBO TEC-03X fully compensates the current injecting microelectrode and needs no virtual ground for recording membrane currents. In addition, a powerful PI (proportional-integral) voltage clamp controller and an improved series resistance compensation unit allow recording of very large voltage activated currents and even gating currents from whole oocytes (Greeff et al., 2000).

The TURBO TEC-03X can be operated with a reduced bandwidth of 10 Hz to allow simultaneous single-channel recordings with patch-clamp amplifiers.

An excellent introduction into recording techniques, preparation of oocytes etc. can be found in "Methods in Enzymology", Vol. 207, 1992 and also in the chapter by Stuehmer et. al. in "Practical Electrophysiological Methods. The basics of microelectrode techniques and voltage clamp principles are described comprehensively in the "Plymouth Workshop Handbook" (Ogden, 1994).

3. TURBO TEC-03X Components

The following items are shipped with the TURBO TEC-03X system:

- ✓ TURBO TEC-03X amplifier
- ✓ Potential headstage
- ✓ Current headstage
- ✓ GND connectors for headstage (2.6 mm)
- ✓ Connectors for current- and reference electrode
- ✓ Power cord
- ✓ User manual

Note: If an electrode holder set (TEC EH-SET) is ordered the connector for the current electrode is not supplied.

Optional accessories:

- ⇨ Electrode adapter
- ⇨ Electrode holder
- ⇨ Electrode holder set
- ⇨ Passive cell model (see chapter 7)
- ⇨ Active cell model

Options:

- ⇨ Interface for CellWorks
- ⇨ Four-pole Bessel current filter
- ⇨ 15V or 45V or 225V output compliance
- ⇨ Current headstage with four ranges

4. TURBO TEC-03X System

This manual refers to the standard configuration of the TURBO TEC-03X system, consisting of a standard headstage and standard calibrations, as written on the front panel.

Other configurations are available (see **Optional accessories** and **Options** in chapter 3). For details contact npj.

4.1. System Description

The TURBO TEC-03X instrument is a voltage/current clamp system that operates according to the classic dual-microelectrode method. This method uses one microelectrode for the registration of membrane potential and one for current injection. The equivalent circuit of a TURBO TEC-03X system and the associated block diagram in VC mode are shown in Figure 1 and Figure 2.

The TURBO TEC-03X system is based on modern state-of-the-art electronic circuits. Its advanced design makes it superior to other amplifiers. Some of the special features of TURBO TEC-03X system are: differential potential registration and high-voltage current

source output, both to eliminate artifacts induced by the use of microelectrodes, full compensation of the current injecting electrode and no need of virtual ground for recording membrane currents. The TURBO TEC-03X has an automated electrode resistance test mode which can be used even with the electrodes impaled in a cell (see Stühmer, 1992, in *Methods in Enzymology*, Vol. 207). In addition, a unique oscillation shutoff circuit prevents the cell from damage if oscillations occur.

The TURBO TEC-03X system can be operated with various software packages. It provides special features such as electronic (remote) selection of modes of operation and monitor (telegraph) signals for the setting of current gain and filters. If the CellWorks software is used, some of the functions of the TURBO TEC-03X can be controlled directly by the computer.

Since the voltage and current clamp techniques are standard techniques of electrophysiology (for reviews see: *Methods in Enzymology*, Vol. 207, Smith et al., 1985, Standen et al., 1987, Kettenmann and Grantyn, 1992, Ogden, 1994), only a short procedural description follows. This description is based on the diagrams of Figure 1 and Figure 2. Terms and abbreviations in capital letters in the text correspond with the labels at the front panel.

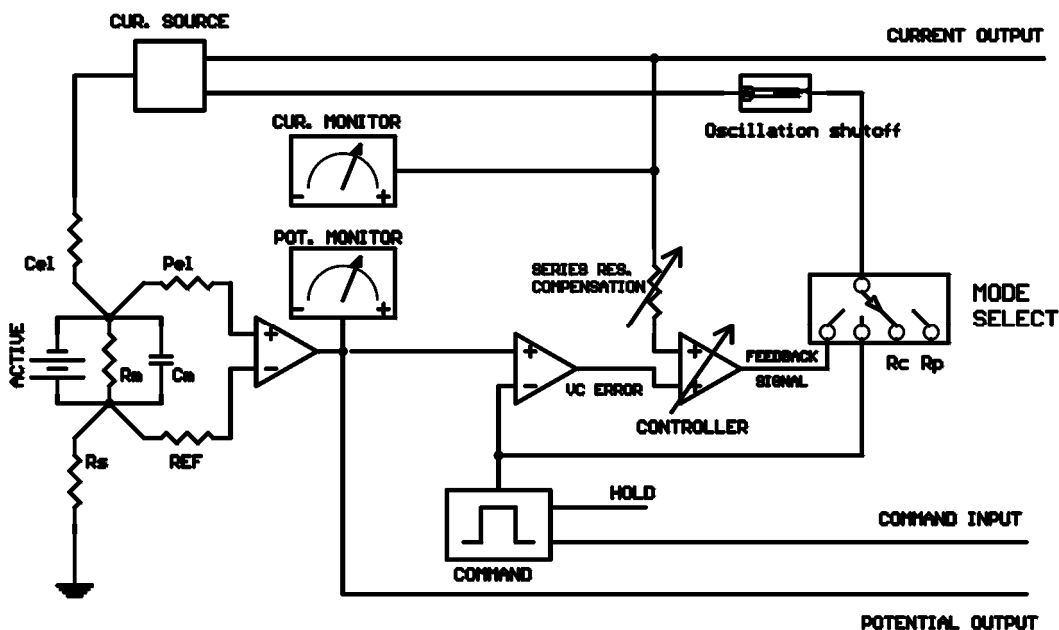

Figure 1: equivalent circuit of TEC amplifiers

Potential Measurement

For membrane potential measurement, all TEC amplifiers use a differential electrode arrangement to record the membrane potential as accurately as possible (see Figure 1), i.e. the membrane potential V_m is measured according to: $V_m = P_{PEL} - P_{REF}$ with P_{PEL} = potential at the potential electrode and P_{REF} = potential at the reference electrode. A description of the potential headstage is given in chapter 5.1.

In order to determine whether both electrodes are inserted into the same cell, the potential of the current injecting microelectrode is recorded by a buffer amplifier in the current headstage. Both potential recording units can be compensated for offsets.

The frequency response of the potential electrode (low-pass characteristic due to stray capacities) is compensated for by a feedback circuit ("negative capacity" compensation, CAPACITY COMPENSATION) and a "driven-shield" arrangement (for an overview see Ogden, 1994). Since in most oocyte experiments microelectrode resistances are usually in the one M Ω range or below, it is not necessary to use CAPACITY COMPENSATION.

Current Injection and Measurement

The current injection is performed by means of a glass microelectrode that is connected to the current headstage (C_{EL}). A description of the current headstage is given in chapter 5.2.

The unique advantage of the instruments in the Turbo TEC series is the voltage-controlled current source output (V/C or V/I converter) for electrical compensation of the disturbances from the microelectrode during current injection (i.e. high resistance and stray capacity, see Polder, 1984; Polder and Swandulla, 1990; Polder and Swandulla, 2001). This current source is built into the current headstage.

The use of a current source output allows measurement of the current en route to the electrode. This is an improvement in accuracy over the "virtual ground" method and also an improvement in ease of use, since it does not require an additional headstage. In addition, the current source method provides an improved frequency response of the voltage clamp control circuit.

On all TEC systems for oocyte recordings, the bandwidth of the current injection electronics can be limited to approximately 10 Hz by means of a switch (BANDW.) on the current headstage (see Figure 9 and Figure 10). This enables simultaneous macrocurrent recording with the TEC system and single channel recording with the patch amplifier, without degradation of the patch amplifier signals from the TEC operation.

Current Clamp Mode (CC)

In the current clamp mode the cell's response to current injections is measured. Current injection is performed by means of a current source connected to the current injecting microelectrode, regardless of the electrode resistance (see Figure 1). Therefore only a current input conditioning unit is necessary for the adequate shaping of the current input signal (COMMAND INPUT). In addition, the TEC-03X is equipped with a HOLD unit for applying a constant holding current. The polarity is controlled by a switch.

Voltage Clamp Mode (VC)

The voltage clamp mode is based on a closed loop control (see Figure 2). In voltage clamp mode, the membrane potential is forced by a controller to maintain a certain value or to follow an external command. That allows measurement of ion fluxes across the cell membrane separate from capacitive currents. This is the most complex mode of operation with the TEC-03X. Special precautions must be taken while tuning the control circuit in order avoid stability problems (see chapters 8.6 and 12).

Important: Although in VC mode one is primarily interested in recording the current flowing across the membrane, the clamp circuit primarily controls the membrane potential. The better the potential is controlled, i.e. the smaller the VC error signal (command voltage minus membrane potential), the more accurate is the recording of membrane currents.

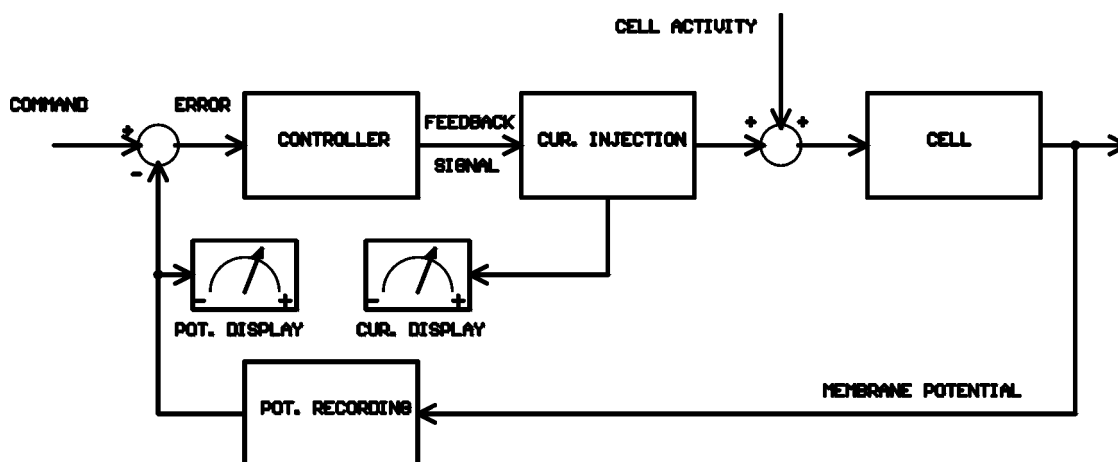

Figure 2: block diagram of VC mode

The COMMAND INPUT is used for the COMMAND signal, and as in the CC mode, the HOLD unit can apply a constant holding voltage.

Note: If no external command signal is connected to the COMMAND INPUT, make sure that an appropriate HOLDING potential in voltage clamp mode is selected (preferable close to the resting membrane potential of the cell).

Without any holding potential, the cell will be clamped to 0 mV if the amplifier is switched to VC mode and that may unintentionally stimulate or damage the cell.

Control Circuit in VC

A detailed description of the basic principals of voltage clamp controls can be found in the literature (e.g. Methods in Enzymology, Smith et al., 1987, Ogden 1994).

In the control circuit (see Figure 1 and Figure 2) the command signal and recorded potential are subtracted to give the VC error signal. This signal is applied to an amplifier with externally controlled variable gain (= proportional gain, set with the GAIN control). The amplified error signal is fed into the current source which injects the necessary amount of current into the cell to compensate for the ionic fluxes across the cell membrane (labeled “active” in Figure 1 and “Cell activity” in Figure 2) and as a result, to keep the membrane potential as close as possible to the command signal. The injected current is recorded by a differential amplifier in the current headstage and is – under stable conditions - a direct measurement of the ion movements across the cell membrane.

Note: To keep the VC error signal as small as possible it is desirable to use high GAIN settings. But if the GAIN is set too high, the system becomes unstable and begins to oscillate. Therefore, the OSCILLATION SHUT-OFF unit should be activated when setting the GAIN.

Control Modes of VC

The control circuit of the TEC-03X systems is operated with two 10-turn controls and a mode select switch. One of three modes can be selected:

- NORMAL (Gain only)
- SLOW (Integrator)
- FAST (Series resistance compensation)

In the NORMAL mode, only the proportional gain described above is active. The gain is set by the GAIN potentiometer.

In the SLOW mode the controller is converted to a PI (proportional-integral) system. The added integrator improves control performance for slow signals. The SLOW mode is designed for recording ligand-gated currents which, in general, are slower than voltage-activated currents.

In the FAST mode the integrator is switched off and a series resistance compensation circuit is activated. The amount of compensation is set by a ten-turn control. Series resistance compensation improves the performance of the clamp system, especially if fast voltage activated currents are recorded.

PI-Controller (SLOW Mode)

The TEC-03X system is equipped with Proportional-Integral (PI) control loops. The VC error signal (command minus recorded signal) is amplified by the GAIN amplifier and applied in addition to an integrator with variable time constant. Consequently, amplification becomes very large for signals with frequencies below the corner frequency of the integrator (reciprocal to the time constant) and this improves the control process. Briefly, the integrator can be understood as an automatic gain setting for slow signals improving clamp accuracy.

The adjustment of the PI control loop is described in chapter 12 (see also Polder and Swandulla, 2001).

Series Resistance Compensation (FAST Mode)

The differential recording arrangement (see chapter 5.1, Figure 1 and Figure 10) suppresses only series resistances outside the cell. In most cells there is also an internal series resistance (e.g. the resistivity of the cytoplasm, of cell organelles, etc.). These series resistances could cause a current-proportional potential error in the voltage clamp mode, i.e. an unwanted change in the membrane potential during a current flow. This change can be partially compensated by current-proportional amplification in the control circuit.

The series resistance compensation circuit compensates resistances in series with the cell membrane by feeding a fraction of the recorded current signal back into the control loop. The output signal is enhanced in a current proportional manner and the effect of the series resistance is minimized. The integrator is switched off.

Important: Series resistance compensation is done by a positive feedback in the control circuit, which has a tendency to oscillate. Thus, whenever possible, repositioning of the electrodes is recommended to minimize series resistance effects. This compensation circuit should be used only as a last resort and with OSCILLATION SHUTOFF unit activated.

Improvement of the Control Properties

Control circuits with negative feedback tend to be unstable as a result of delays inherent to the system (e.g. low-pass characteristics of the microelectrodes) or positive feedback caused by capacitive couplings between the electrodes.

In voltage clamp systems, the control properties can be substantially improved by shielding the electrodes from each other. Often shielding of the current electrode suffices to reduce the coupling capacity between the electrodes. This shield can be connected to GND of the current headstage. The potential electrode can be shielded using a "driven shield" arrangement (see Ogden, 1994).

Note: In experiments with oocytes shielding of the electrodes is usually **not** necessary!! If shielding is required in special experimental situations we recommend learning about this technique from articles such as Ogden, 1994 and Smith, 1985.

The correct setting of the C-compensation increases the speed of response of the control loop, but also increases the noise. The settings of the different parameters result in a compromise between the stability, accuracy, noise and control speed. Adjustment criteria are discussed in chapter 12 (also see Polder and Swandulla, 2001). Some practical hints are given in sections 8.6 and 12.2).

4.2. Description of the Front Panel

The TURBO TEC-03X system is made up of a 19" basic system with a built-in power supply and two headstages: a smaller one for potential recording and a bigger one for current injection and recording.

In the following description, numbering of the items is based on the diagram in Figure 3. The number is followed by the name (in uppercase letters) written on the front panel and the type of the element (in lowercase letters). Then, a short description of the element is given. Some elements are grouped in functional units (e.g. **Current output unit**) and are described as units regardless of the order of numbers.

In general, the front panel of the TURBO TEC-03X is arranged so that elements concerning current clamp mode of the amplifier are located at the right half of the front panel. Elements related to voltage clamp mode are found on the left side of the front panel. Each control element has a label and frequently a calibration (e.g. CURRENT OUTPUT SENSITIVITY, V/ μ A).

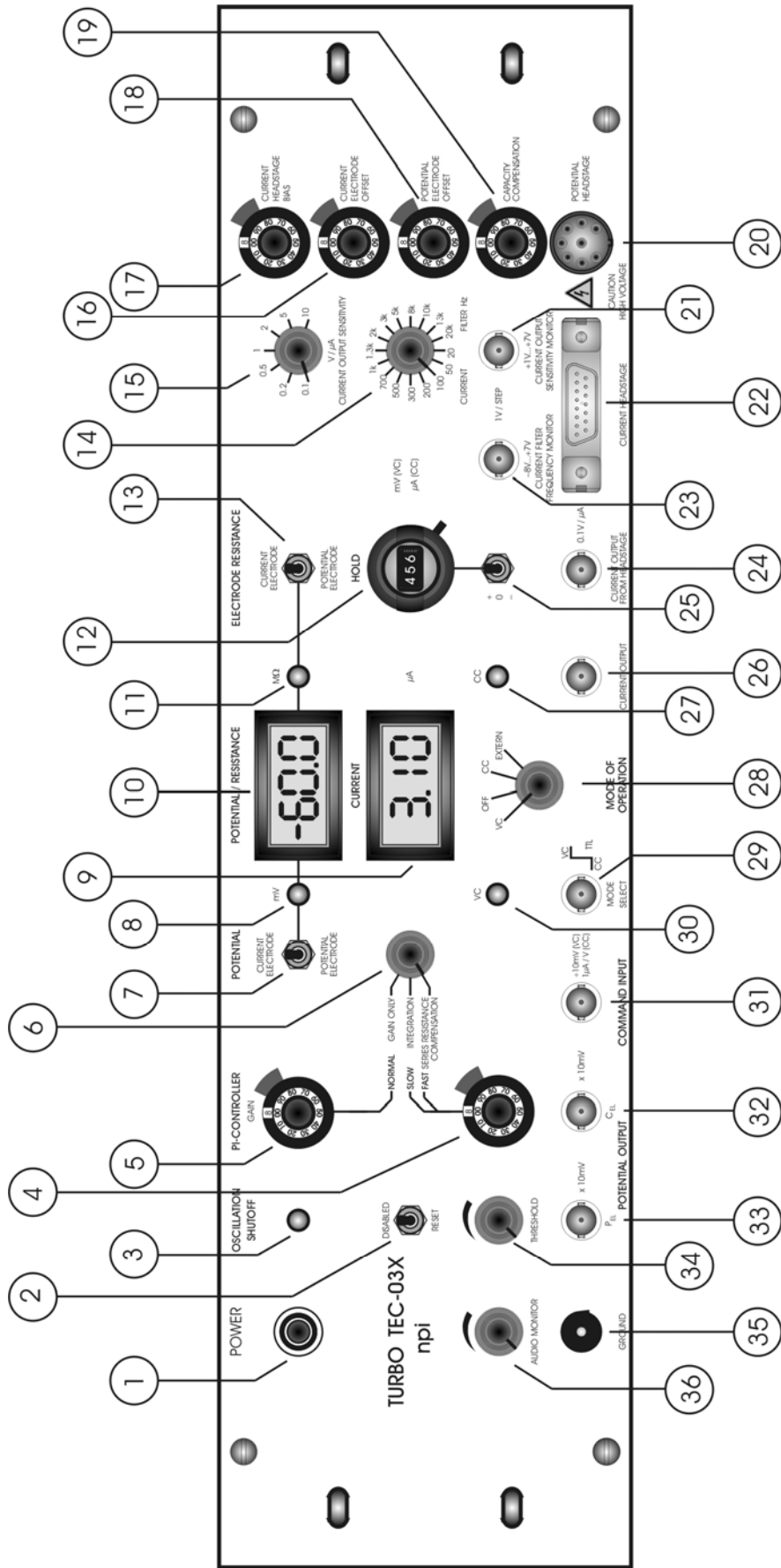

Figure 3: TURBO TEC-03X front panel view (the numbers are related to those in the text below)

(1) POWER switch

Switch to turn POWER on (switch pushed) or off (switch released).

OSCILLATION SHUTOFF unit

The OSCILLATION SHUTOFF unit consists of **(2)** DISABLED / RESET switch, **(3)** OSCILLATION SHUTOFF LED and **(34)** THRESHOLD potentiometer. In SHUTOFF condition the amplifier is set into CC mode and all outputs (including holding current) and CAPACITY COMPENSATION are disabled. The inputs and the ELECTRODE RESISTANCE test are activated.

(3) OSCILLATION SHUTOFF LED

Indicates whether the OSCILLATION SHUTOFF circuit is in SHUTOFF condition (LED red) or not (LED green).

(34) THRESHOLD potentiometer

Control to set the activation THRESHOLD of the OSCILLATION SHUTOFF circuit (potentiometer, linear clockwise, range: 0-1200 mV).

(2) DISABLED / RESET switch

Switch to DISABLE the OSCILLATION SHUTOFF unit or to RESET the circuit. A RESET is carried out if one wants to reset the circuit after a previous SHUTOFF condition. After resetting the OSCILLATION SHUT-OFF unit is active again.

Voltage clamp control unit

The voltage clamp control unit consists of **(5)** GAIN potentiometer, **(4)** PI-CONTROLLER potentiometer and **(6)** control mode switch (see also chapter 8.6).

(5) GAIN potentiometer

10-turn potentiometer to set amplification factor (GAIN) of the VC error signal (see also chapter 4.1). To keep the VC error as small as possible it is necessary to use high GAIN settings, but the system becomes unstable and begins to oscillate if the GAIN is set too high. Thus, the OSCILLATION SHUT-OFF circuit (see above) should be activated when setting this control.

(4) PI-CONTROLLER potentiometer

10-turn potentiometer to set either the time constant of the integrator in SLOW mode, or the amount of series resistance compensation in FAST mode (see also **(6)**).

(6) control mode switch

Switch to select the control mode. Three modes are possible:

- **NORMAL**. In this mode only the proportional gain (see above) is active. The gain is set by **(5)**.
- **SLOW**. In the SLOW mode the controller is converted into a PI (proportional-integral) system. The integrator improves control performance for slow signals, e.g. during recording of ligand-gated currents. The time constant is set by **(4)**.
- **FAST**. In the FAST mode the integrator is switched off and a **SERIES RESISTANCE COMPENSATION** circuit is activated. **SERIES RESISTANCE COMPENSATION** improves the performance of the clamp system, especially if fast voltage-activated currents are recorded. The amount of compensation is set by **(4)**.

DISPLAY unit

The DISPLAY unit consists of **(7)** electrode selector for POTENTIAL, **(8)** mV LED, **(9)** CURRENT display, **(10)** POTENTIAL / RESISTANCE display, **(11)** MΩ LED and **(13)** electrode selector for RESISTANCE.

(7) Electrode selector POTENTIAL

This switch selects whether the potential of CURRENT ELECTRODE or POTENTIAL ELECTRODE is displayed (see **(10)** below).

(8) mV LED

When lit, indicates that POTENTIAL (mV) is revealed in DISPLAY **(10)**.

(9) CURRENT display

LC-Display for the CURRENT passed through the CURRENT electrode in μA (X.XX μA).

(10) POTENTIAL / RESISTANCE display

LC-Display for the POTENTIAL at the electrode tip in mV (XXX mV) or the electrode RESISTANCE in MΩ (XX.X MΩ, i.e. 01.0 corresponds to 1.0 MΩ). The electrode is selected by electrode selector **(7)** for POTENTIAL measurement and by electrode selector **(13)** for ELECTRODE RESISTANCE.

(11) MΩ LED

When lit, indicates that RESISTANCE (MΩ) is revealed in DISPLAY **(10)**.

(13) Electrode selector ELECTRODE RESISTANCE

Switch to select the electrode to measure the RESISTANCE from. Three position switch, CURRENT ELECTRODE, off, POTENTIAL ELECTRODE. Switching to CURRENT- or

POTENTIAL ELECTRODE tests the RESISTANCE by applying current pulses of ± 10 nA to the respective electrode. In off position the ELECTRODE RESISTANCE test is disabled.

HOLD unit



The HOLD unit consists of **(12)** HOLD current potentiometer and **(25)** + / 0 / - switch.

(12) HOLD current / potential potentiometer

10-turn digital control that presets a continuous command signal (HOLD potential (XXX mV, maximum: 999 mV) for VC or HOLD current (X.XX μ A, maximum 9.99 μ A) for CC). Polarity is set by switch **(25)**.

(25) + / 0 / - switch

Toggle switch to set the polarity of HOLD current / potential or to disable HOLD current / potential. (+: positive HOLD current / potential, 0: HOLD current / potential turned off, -: negative HOLD current / potential).

CURRENT OUTPUT conditioning unit



The CURRENT OUTPUT conditioning unit consists of **(14)** CURRENT FILTER Hz, **(15)** V / μ A CURRENT OUTPUT SENSITIVITY, **(21)** +1V...+7V CURRENT OUTPUT SENSITIVITY MONITOR connector and **(23)** -1V...+7V FREQUENCY MONITOR connector.

(14) CURRENT FILTER Hz switch

16-position switch to set the corner frequency of the Bessel filter. The setting is monitored by **(23)**.

(15) V / μ A CURRENT OUTPUT SENSITIVITY switch

7-position switch to set the CURRENT OUTPUT gain. The setting is monitored by **(21)**.

(21) +1V...+7V CURRENT OUTPUT SENSITIVITY MONITOR connector

BNC output connector monitoring the setting of **(15)** V / μ A CURRENT OUTPUT SENSITIVITY switch. Resolution 1 V / STEP (i.e. 3V indicate a GAIN of 0.5).

(23) -8V...+7V CURRENT FILTER FREQUENCY MONITOR connector

BNC output connector monitoring the setting of **(14) CURRENT FILTER Hz** switch. Resolution 1 V / STEP (i.e. 5V indicate a filter frequency of 10 kHz).

(16) CURRENT ELECTRODE OFFSET potentiometer

Control to compensate the current electrode potential (ten-turn potentiometer, symmetrical, i.e. 0 mV = 5 on the dial), range: ± 500 mV (see chapter 8.2).

(17) CURRENT HEADSTAGE BIAS potentiometer

With this 10 turn potentiometer the output current of the CURRENT HEADSTAGE (headstage BIAS current) can be tuned to 0 (see chapter 8.1).

(18) POTENTIAL ELECTRODE OFFSET potentiometer

Control to compensate the potential electrode potential (ten-turn potentiometer, symmetrical, i.e. 0 mV = 5 on the dial), range: ± 300 mV (see chapter 8.2).

(19) CAPACITY COMPENSATION potentiometer

Control for the capacity compensation of the POTENTIAL electrode (ten turn potentiometer, clockwise, range: 0-30 pF, see chapter 8.4). Usually not used in oocyte experiments.

Caution: This circuit is based on a positive feedback circuit. Overcompensation leads to oscillations that may damage the cell.

(20) POTENTIAL HEADSTAGE connector

The POTENTIAL HEADSTAGE is connected via a flexible cable and a 12-pole connector to the mainframe (see also chapter 5.1).

Caution: Please always adhere to the appropriate safety regulations (see chapter 1). Please turn power off when connecting or disconnecting the potential headstage from the POTENTIAL HEADSTAGE connector!

(22) CURRENT HEADSTAGE connector

The CURRENT HEADSTAGE is connected via a flexible cable and a 15-pole connector to the mainframe (see also chapter 5.2).

Caution: Please always adhere to the appropriate safety regulations (see chapter 1). Please turn power off when connecting or disconnecting the current headstage from the CURRENT HEADSTAGE connector!

CURRENT OUTPUT unit

The CURRENT OUTPUT unit consists of **(24) CURRENT OUTPUT FROM HEADSTAGE** connector and **(26) CURRENT OUTPUT** connector.

(24) CURRENT OUTPUT FROM HEADSTAGE connector

BNC connector providing the CURRENT OUTPUT signal directly from the CURRENT HEADSTAGE, sensitivity $0.1 \text{ V} / \mu\text{A}$.

(26) CURRENT OUTPUT connector

BNC connector providing the CURRENT OUTPUT signal after passing the CURRENT OUTPUT conditioning unit (see also **CURRENT OUTPUT conditioning unit** earlier in this chapter).

(27) CC LED, (30) VC LED

LEDs indicating the selection of Current Clamp mode **(27)** or Voltage Clamp mode **(30)**.

(28) MODE OF OPERATION switch

Switch to select the MODE OF OPERATION:



VC: Voltage Clamp

OFF: In this position the amplifier is in current clamp mode, but does not apply any current to the cell, i.e. only the membrane potential is recorded.

CC: Current Clamp

EXT.: EXTernal control; if this position is selected, the mode of operation can be set by a TTL pulse applied to the MODE SELECT BNC **(29)**. If CellWorks is used, some functions can be controlled from CellWorks (TEC-03X-CW).

(29) MODE SELECT connector



BNC connector for remote control of the MODE of operation. A TTL signal is connected here to select the mode of operation remotely (HI = VC, LO = CC).

(31) COMMAND INPUT connector



BNC connector for an external COMMAND in VC mode (sensitivity: ± 10 mV) or in CC mode (sensitivity: $1 \mu\text{A} / \text{V}$).

The voltage signal that is connected here is transformed to a proportional current at the electrode in CC mode or COMMAND voltage in VC mode. The signal form remains unchanged. Two examples are given in Figure 4. The amplitude of the output current or voltage signal (current / voltage stimulus) is determined by the amplitude of the input voltage signal.

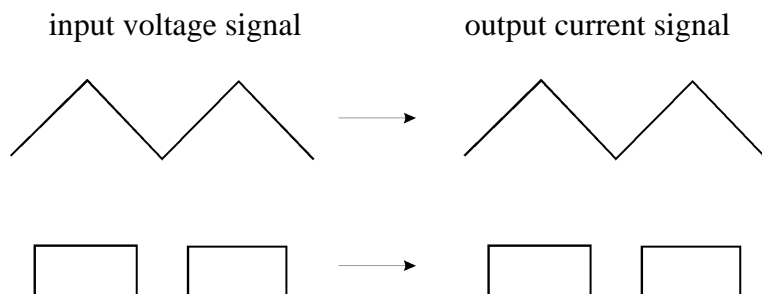

Figure 4: input-output relation using COMMAND INPUT in CC mode

(32) POTENTIAL OUTPUT connector C_{EL}



BNC connector monitoring the POTENTIAL at the tip of the CURRENT electrode (C_{EL} , sensitivity: $\times 10$ mV).

(33) POTENTIAL OUTPUT connector P_{EL}



BNC connector monitoring the POTENTIAL at the tip of the POTENTIAL electrode (P_{EL} , sensitivity: $\times 10$ mV).

(35) GROUND connector



Banana jack providing the internal GROUND (not connected to PROTECTIVE EARTH).

(36) AUDIO MONITOR potentiometer



Volume control for the AUDIO MONITOR. The potential at the electrode selected by switch (7) is monitored by a sound. The pitch of sound is related to the value of the potential.

4.3. Description of the Rear Panel

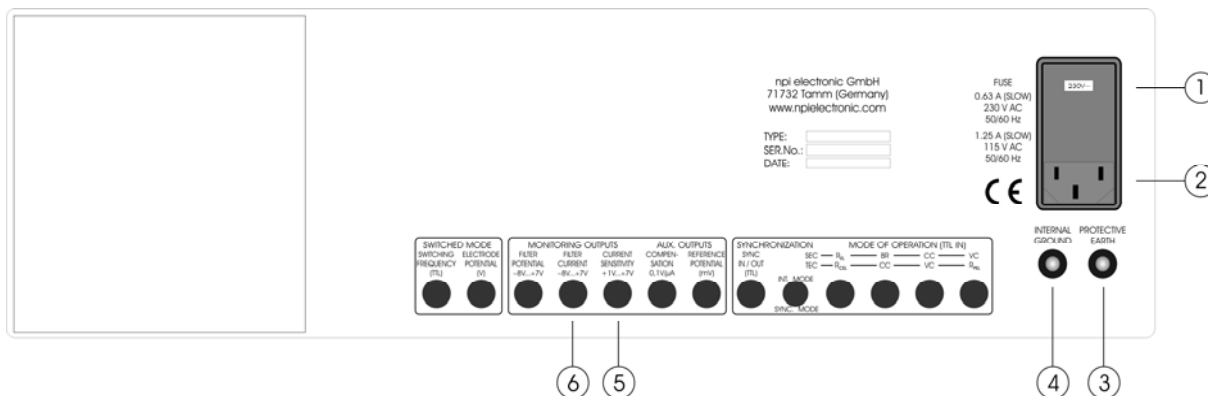

Figure 5: TURBO TEC-03X rear panel view (the numbers are related to those in the text below)

(1) FUSE holder

Holder for the line fuse and line voltage selector. For changing the fuse or selecting line voltage open the flap using a screw driver. The fuse is located below the voltage selector. Pull out the holder (indicated by an arrow), in order to change the fuse. For selecting the line voltage, rotate the selector drum until the proper voltage appears in the front.

(2) Mains connector

Plug socket for the mains power-plug.

Important: Check line voltage before connecting the TEC amplifier to power. Always use a three-wire line cord and a mains power-plug with a protection contact connected to ground. Disconnect mains power-plug when replacing the fuse or changing line voltage. Replace fuse only by appropriate specified type. Before opening the cabinet unplug the instrument.

(3) PROTECTIVE EARTH connector

Banana plug providing mains ground (see below).

(4) INTERNAL GROUND connector

Banana plug providing internal ground (see below).

(5) CURRENT SENSITIVITY connector

BNC connector providing a voltage monitoring the position of the CURRENT OUTPUT SENSITIVITY switch (+1 V to +7 V, 1V/STEP). See also #21, Figure 3.

TEC-03X-CW

In order to connect the amplifier directly to a computer with a National Instruments (NI) data acquisition board of the E-Series, the TEC-03X-CW has additional connectors at the rear panel (see Figure 6).

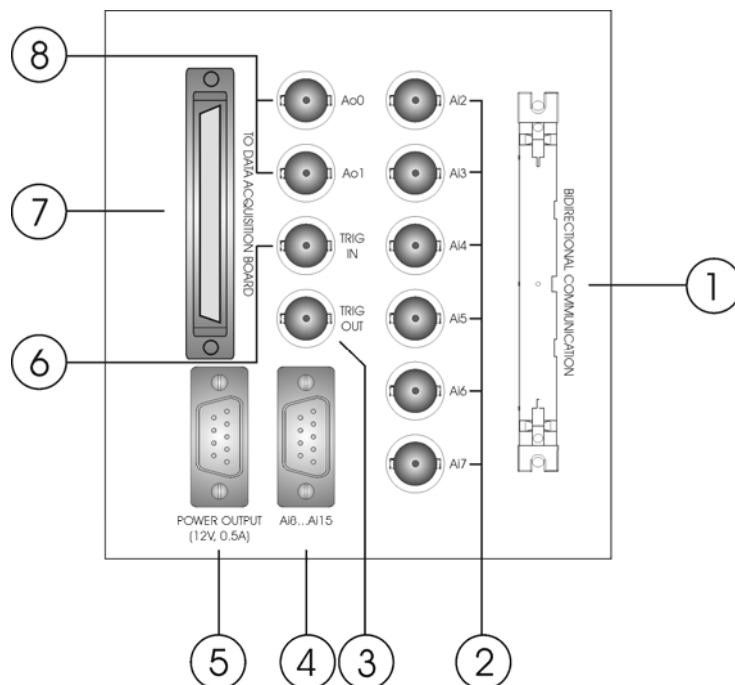

Figure 6: breakout box connectors of the TEC-03X-CW

(1) BIDIRECTIONAL COMMUNICATION connector (option)

Optional 50-pole SCSI connector for **BIDIRECTIONAL COMMUNICATION** between CellWorks and TEC-03X-CW. **BIDIRECTIONAL COMMUNICATION** is performed using two digital ports of a PCI-6503 digital I/O board (NI) linked to this connector (see also CellWorks Manual).

(2) Ai2 - Ai7 connectors

BNC input connectors for Ai2 – Ai7 of the National Instruments board.

Note: Ai0 and Ai1 are not available at the rear panel of the TEC-03X-CW. These channels are used for recording current- (Ai0) and voltage signals (Ai1) from the amplifier and therefore, these signals are internally connected to Ai0 (current) and Ai1 (voltage).

(3) TRIG OUT

Output BNC connector providing a TTL (+5 V) trigger if a pulse routine (or snapshot) in CellWorks is activated (see Figure 7). This signal indicates that CellWorks is waiting for a trigger signal before starting pulses and recording.

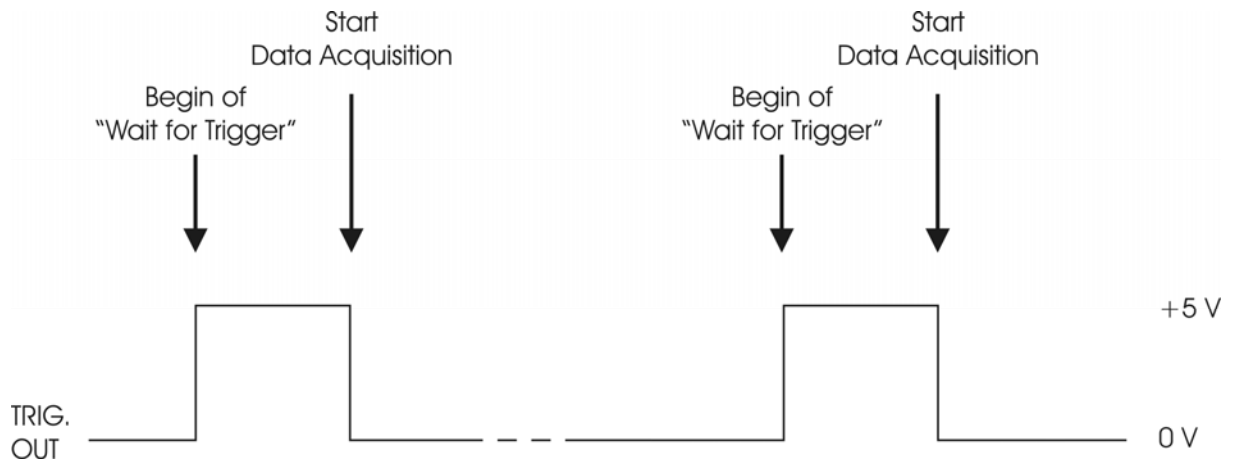

Figure 7: timing of the TRIG.OUT signal

(4) Ai8 – Ai15

9 pole male SUBD connector providing Ai8 – Ai15 of the National Instruments board.

(5) POWER OUTPUT (12V, 0.5A)

9 pole female connector for devices controlled by digital pulses from CellWorks, e.g. valves of a perfusion system. Specification: 12 V, 0.5 A, sufficient for most pinch valve manifolds, e.g. ALA-VM8-PG.

(6) TRIG. IN (TTL)

Input BNC connector for triggering CellWorks. If the user has started a pulse (or snapshot) protocol in CellWorks via double click and CellWorks is configured to wait for a trigger, a TTL pulse applied to this input will cause CellWorks to start the protocol.

(7) TO DATA ACQUISITION BOARD connector

68-pole SCSI connector for connecting a multi-function I/O board of the B, E or M-Series of National Instruments.

(8) Ao0 and Ao1 connectors

BNC output connectors providing DAC0 and DAC1 of the National Instruments board.

Important: These signals are generated from the NI board and Ao0 (DAC0) is connected additionally to the command input port of the amplifier. If the user unintentionally connects a signal to COMMAND INPUT BNC at the front panel, this signal will be added to the value of the command input signal for the TEC-03X-CW generated by CellWorks.

A procedure to test the data acquisition board from National Instruments is described in chapter 8.7.

5. Headstages

The TEC-03X comes with two standard headstages: the POTENTIAL HEADSTAGE for recording the membrane potential and the CURRENT HEADSTAGE for injecting current into the cell.

5.1. Potential Headstage

The potential headstage is housed in a small box containing the buffer amplifiers to record the membrane potential (see Figure 8). The enclosure of the headstage is linked to ground. A metal bar is mounted to this box allowing direct attachment to a micromanipulator. The headstage is connected to the 19" cabinet by a flexible shielded cable via the POTENTIAL ELECTRODE connector. The recording microelectrode can be connected by using an electrode holder with a BNC socket. The electrical connection between the electrolyte and the headstage is established using a carefully chlorinated silver wire in the electrode holder. Chlorinating of the silver wire is very important since contact of silver to the electrolyte leads to electrochemical potentials, causing varying offset potentials at the electrode, deterioration of the voltage measurement, etc. (for details see Kettenmann and Grantyn (1992)). For optimal chlorinating of silver wires an automated chlorinating apparatus is available (ACI-01, contact npi for details). GND and REF. are connected by flexible cables with appropriate connectors.



Figure 8: potential headstage and electrode holder (optional)

Headstage Elements

- 1 BNC connector for the electrode holder (optional)
- 2 REF: reference electrode connector
- 3 GND: ground connector
- 4 Headstage cable to amplifier

Two electrodes, an intracellular microelectrode (P_{EL} = potential electrode) and an extracellular electrode (REF= reference electrode), are required for potential measurement. Both are connected to high impedance buffers (input resistance higher than $10^{13} \Omega$) in the potential headstage. In addition, the bath surrounding the cell must have a solid ground connection (Ag-AgCl pellet or Agar bridge, see Figure 10) that can carry large membrane currents flowing during voltage clamp experiments with oocytes.

The optimal configuration for the headstage connections is shown in Figure 10. This arrangement (differential-measurement arrangement) ensures the most accurate measurement of the membrane potential. The reference electrode (REF) is placed near the membrane of the oocyte and measures the bath potential (extracellular potential). The bath potential is subtracted from the intracellular potential recorded by the intracellular electrode (P_{EL}). Electrodes used for intracellular potential measurement in oocytes typically have resistances of 700 k Ω up to 1-2 M Ω .

Important: The shield of the BNC connector is linked to the driven shield output and must not be connected to ground.

If REF is **not** used, it must be connected to ground.

Warning: This headstage contains amplifiers which may be damaged by static electricity. This can be avoided by touching a grounded metal surface when changing or adjusting the electrodes. If a headstage is not used the input should always be connected to ground (either using an appropriate connector or with aluminum foil wrapped around the headstage). In addition, it is extremely important that the instrument is turned off when changing the headstage.

5.2. Current Headstage

The current headstage (see Figure 9) contains the circuits for current injection and recording as well as the preamplifier for potential measurement of the current electrode (see also chapter 8.2 and chapter 9). Since high voltage amplifiers are used it is rather large. It is not intended that the current headstage is attached directly to a micromanipulator. An electrode holder adapter is used instead. The headstage is connected to the 19" cabinet by a flexible shielded cable through the CURRENT HEADSTAGE connector.



Figure 9: current headstage with (optional) electrode holder and (optional) electrode holder adapter of the TEC-03X system

The current headstage has the following elements:

- 1 C_{EL} : Connector for the current electrode, grounded shield
- 2 BANDWIDTH 10 Hz: switch for low bandwidth (10 Hz) operation
 WIDEBAND = full bandwidth, 10 Hz = low noise (for simultaneous patch clamp recording)
- 3 headstage cable to amplifier

Usually the current electrode is connected to the headstage via an electrode holder that fits into the electrode adapter that is linked to the current electrode connector. The electrical connection between the electrolyte and the headstage is established using a carefully chlorinated silver wire in the electrode holder. Chlorinating of the silver wire is very important since contact of silver to the electrolyte leads to electrochemical potentials causing varying offset potentials at the electrode, deterioration of the voltage measurement and other problems (for details see Kettenmann and Grantyn (1992)). For optimal chlorinating of silver wires an automated apparatus is available (contact npj for details).

The electrode adapter can be mounted into a commercial micromanipulator near the bath while the headstage is placed somewhere nearby. Electrodes used for current injection into oocytes typically have resistances of 500 k Ω to 1 M Ω .

The unique advantage of the instruments in the Turbo TEC series is the voltage-controlled current source output (V/C or V/I converter), for electrical compensation of the disturbances from the microelectrode during current injection (i.e. high resistance and stray capacity, see Polder, 1984, Polder and Swandulla, 1990). This current source is built into the current headstage.

The use of the current source output allows that the current is measured en route to the electrode. This is an improvement in ease of use compared to the "virtual ground" method that requires an additional headstage. Furthermore, the current source method also provides an improved frequency response of the voltage clamp control circuit.

On all TEC systems for oocyte recordings, the bandwidth of the current injection electronics can be limited to approximately 10 Hz by means of a switch (BANDW.) on the current headstage (see Figure 9 and Figure 10). This allows the use of a patch clamp amplifier for single channel recording simultaneously to recording macro-currents with the TEC system without excessive noise from the two electrode clamp loop. In this mode the clamp circuit is capable of following only slow changes, i.e. to keep the steady-state.

Important: The controller must be used in P-mode (INTEGRATOR = OFF) since parasitic oscillations may occur due to the limited bandwidth of the current source (two integral components in a closed loop form an oscillator, see Froehr, 1985 for details).

Warning: The current injection headstage has a ± 150 V output compliance. After turning on the instrument, it must be ensured that the interior contact and the shield of the electrode plug and of the cable that is connected to this plug cannot be touched.

In addition, it is extremely important that the instrument is turned off when changing or adjusting the electrodes.

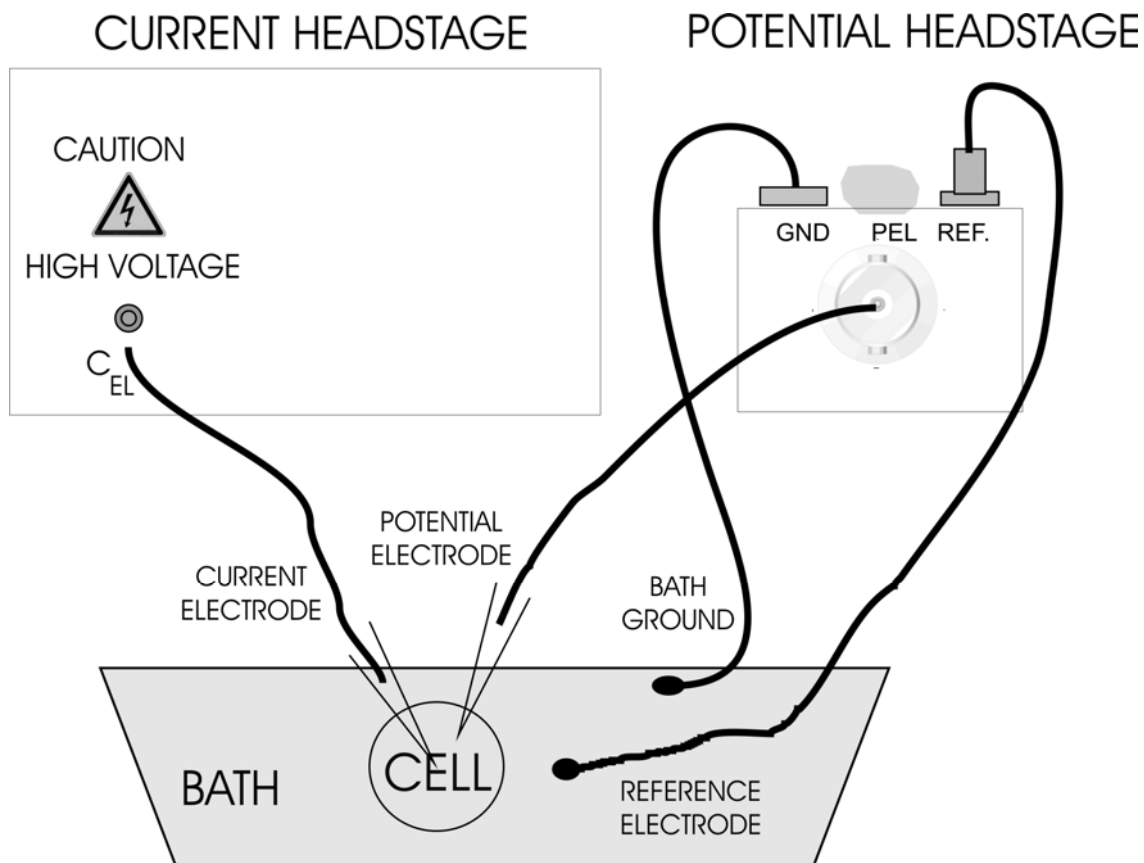

Figure 10: connections of the headstages

Options

The TEC-03X can be ordered with a current headstage providing four ranges:

- x0.1, x1, x2 and x5.

The x1 position corresponds to the calibrations at the front panel.

In the x0.1 position all current input and output signals must be divided by 10 and the reading of the current electrode resistance must be multiplied by 10.

In the x2 (x5) position the current signals have to be multiplied by 2 (by 5) while the reading of the current electrode resistance must be divided by 2 (by 5). These modes are suitable for recording very large currents (e.g. K-currents larger than $100\mu\text{A}$) with current electrodes up to ca. $500\text{ k}\Omega$ ($200\text{ k}\Omega$). The maximum current is ca. $300\text{ }\mu\text{A}$ ($500\text{ }\mu\text{A}$).

For measuring smaller currents another headstage with four ranges is available:

- x0.1, x0.2, x0.5 and x1.

All current input and output signals have to be multiplied by the factor that is set at the 4-position switch at the headstage, e.g. in the x0.1 position all current input and output signals must be divided by 10 and the reading of the current electrode resistance must be multiplied by 10.

Note: We recommend always measuring the electrode resistance in x1 position!

6. Setting up the TEC-03X

The following steps should help you to set up the TEC-03X correctly. Always adhere to the appropriate safety measures (see chapter 1). The headstages are very sensitive and may be damaged by static electricity. This can be avoided by touching a grounded metal surface when handling headstages. If a headstage is not used, the input should always be connected to ground (either using an appropriate connector or with aluminum foil wrapped around the headstage).

After unpacking, the TEC-03X is attached to the setup by assembling the electrical connections. It is assumed that a passive cell model will be attached. The connection of the Ag-AgCl pellet or the agar-bridge for grounding the bath is described in chapter 9.

All numbers are related to those in Figure 3.

① Electrical connections

- Turn POWER off.
- Plug the instrument into a grounded outlet.
- Connect the potential headstage to the POTENTIAL HEADSTAGE connector (#20) at the TEC-03X.
- Connect the current headstage to the CURRENT HEADSTAGE connector (#22) at the TEC-03X.
- Connect a cell model (see chapter 7.2). Connect a digital/analog timing unit or a stimulation device to COMMAND INPUT (#31).
- Connect a storage oscilloscope or a data recording device (i.e. a computer with data acquisition card) to the POTENTIAL OUTPUT PEL and to the CURRENT OUTPUT triggered from the stimulation device. We recommend always using an oscilloscope in addition to the computer system. Set the desired gain at the CURRENT OUTPUT SENSITIVITY switch (#15) and set the CURRENT FILTER (#14) to 20k.

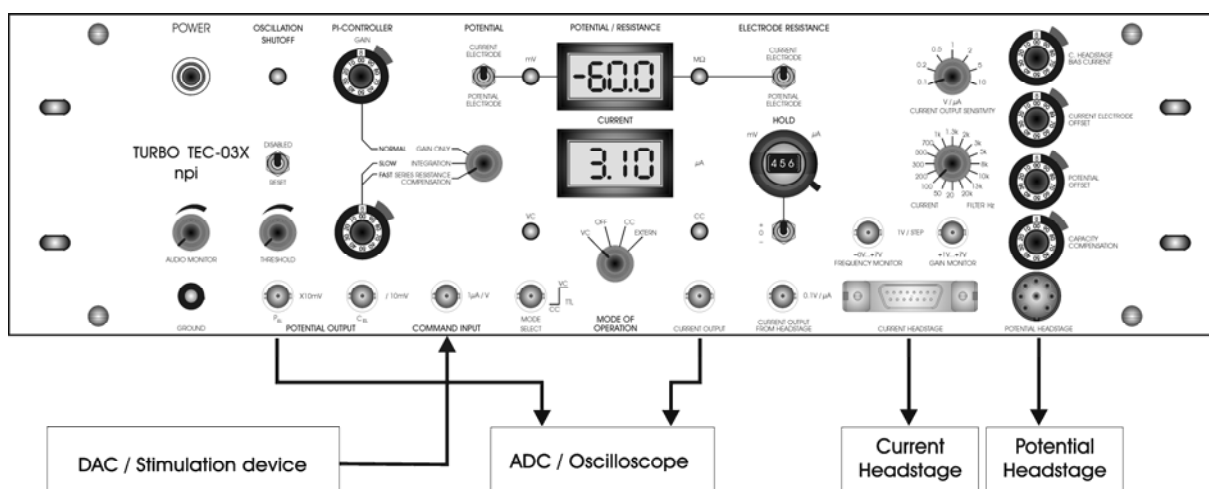

Figure 11: basic electrical connections

Before using the TEC-03X always make the basic settings to avoid oscillations.

② Basic settings

- Turn all controls to low values (less than 1) and each symmetrical offset adjustment, i.e. C. HEADSTAGE BIAS CURRENT, CURRENT ELECTRODE OFFSET and POTENTIAL OFFSET potentiometers, in the range of 5 (zero position, see chapter 4.2). Set the CAPACITY COMPENSATION (#19) to 0.
- Disable the HOLD unit by setting the + / 0 / - switch (#25) to 0.
- Set the MODE OF OPERATION (#28) to CC.
- Set the display to POTENTIAL ELECTRODE using switch #7.
- Turn POWER switch on.

Now the TEC-03X is ready for an initial check with the cell model.

7. Passive Cell Model

The TEC-03X can be ordered with a passive TEC (Two Electrode Clamp amplifier) cell model as an optional accessory. An active cell model is also available on request (for reference see Draguhn et al. (1997)).

The passive cell model is designed for use with TEC amplifiers to check the function of the instrument in the following circumstances:

1. just after unpacking to see whether the instrument has been damaged during transport or
2. to train personnel in using the instrument or
3. in case of trouble (see also chapter 11) to check which part of the setup does not work correctly, e.g. to find out whether the amplifier or headstages are damaged or something is wrong with the electrodes or holders etc.

The passive cell model consists only of passive elements i.e. resistors that simulate the resistance of the cell membrane and the electrodes and a capacity simulating the capacity of the cell membrane (see Figure 12 and Figure 13). A switch allows simulation of two different membrane resistances: 10 k Ω and 100 k Ω . A second switch permits grounding the current electrode (see also chapter 8.1).

7.1. Cell Model Description

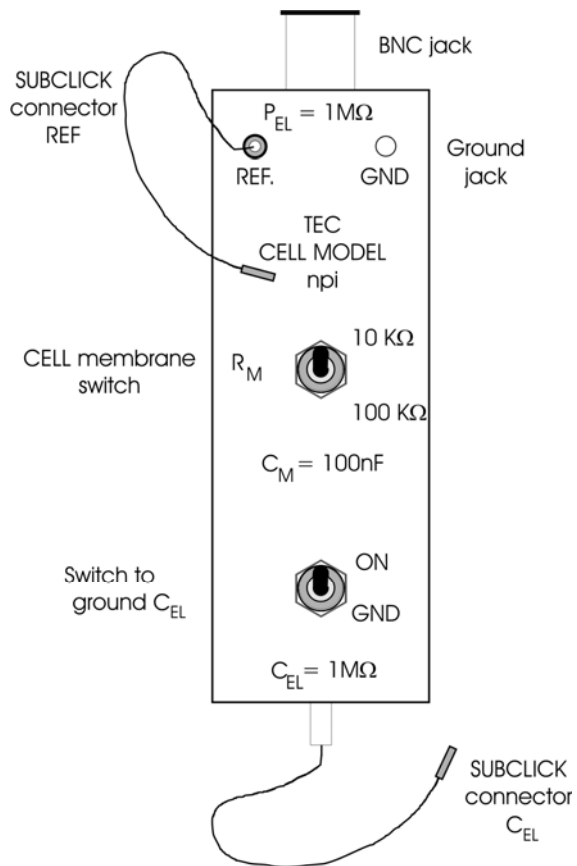

Figure 12: TEC passive cell model

- P_{EL} BNC: connector for the potential electrode, resistance: $1\text{ M}\Omega$
 REF SUBCLICK: subclick (SMB) connector for the reference electrode
 GND: ground connector
 R_M : switch for the cell membrane representing a membrane resistance of either $10\text{ k}\Omega$ or $100\text{ k}\Omega$
 C_M : cell membrane capacity, always 100 nF
 ON / GND: switch to ground the current electrode, ON = C_{EL} inside the cell, GND = C_{EL} connected to ground (see also chapter 8.1)
 C_{EL} SUBCLICK: SMC connector for the current electrode, resistance: $1\text{ M}\Omega$

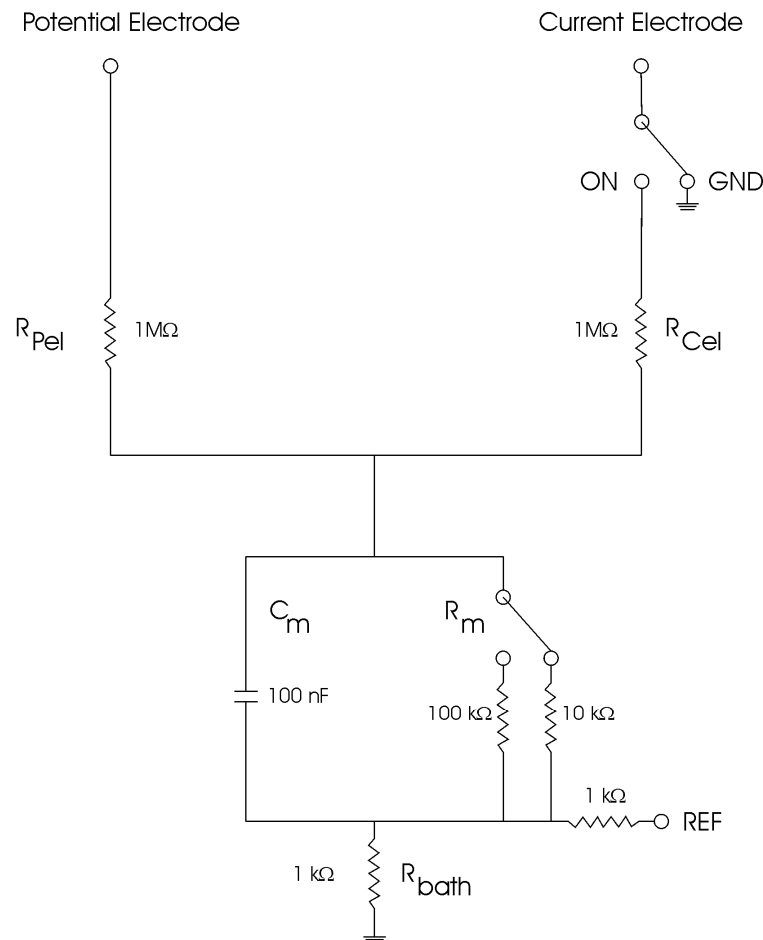

Figure 13: schematic diagram of the TEC passive cell model

7.2. Connections and Operation

Checking the Configuration with the Cell Model

- Make the basic settings (see chapter 6).
- Connect the P_{EL} BNC jack of the cell model to the BNC connector at the potential headstage.
- Connect the SUBCLICK connector REF. to the REF. connector at the potential headstage.
- Connect the SUBCLICK connector C_{EL} to the plug at the current headstage.
- Switch the CELL membrane switch (see Figure 12) to the desired position.
- Set the GND switch (see Figure 12) to ON.
- Turn POWER switch of the amplifier on.

Now you can adjust the amplifier and apply test pulses to the cell model. Connection to the BNC- and SUBCLICK connector, respectively, gives access to the cell via a potential and current electrode with 1 MΩ resistance. In the upper position the R_M switch simulates a cell

membrane with a resistance of 10 k Ω . In the lower position a cell membrane with 100 k Ω is simulated. The membrane capacity is always 100 nF (see also chapter 8.5).

8. Test and Tuning Procedures

Important: The TEC-03X should be used only in warmed-up condition, i.e. 20 to 30 minutes after turning power on.

The following test and tuning procedures are necessary for optimal recordings. It is recommended first to connect a cell model to the amplifier to perform some basic adjustments and to get familiar with these procedures. It is assumed that all connections are as described in chapter 6. All numbers are related to those in Figure 3.

8.1. Current Headstage Bias Current Adjustment

Caution: It is important that this tuning procedure is performed ONLY after a warm-up period of at least 30 minutes!

The tuning procedure must be performed regularly (at least once a month) with great care since the bias current changes over time and it determines the accuracy of the TEC system.

The TEC-03X is equipped with a high-voltage current source that is connected to the current injecting electrode and performs the current injection (see chapter 4.1). This current source has a high-impedance floating output. Therefore the zero point (the zero of the bias current) of the current source must be defined, i.e. without an input signal there should not be an output current.

Since the high-voltage FET amplifiers that are used become warm from the internal heat dissipation and their characteristics are strongly temperature dependent, the calibration procedure has to be done periodically by the user.

The tuning procedure is done using the C. HEADSTAGE BIAS CURRENT control and one resistance of a few k Ω and one of a few M Ω or a cell model. It is based on Ohm's Law ($U = R * I$).

If the headstage generates an output current, this current will cause a voltage deflection at a test resistor. If this test resistor has a low resistance of only a few k Ω this voltage deflection is nearly zero, and a possible reading at the digital display originates only from a possible offset of the electrode, which can be cancelled using the CURRENT ELECTRODE OFFSET (#16) potentiometer. Replacing the low resistance resistor by one of a much higher resistance may lead to another voltage reading at the digital display. This voltage deflection then originates only from the BIAS output current and is proportional to this output current according to Ohm's law. Using the C.HEADSTAGE BIAS CURRENT control the monitored voltage can be set to 0.

The tuning procedure is performed using high-value resistors or a cell model. It cannot be performed with an electrode, since there are always unknown potentials involved (tip potential, junction potentials etc.).

Warning: High voltage! Always turn power off when working directly on the current headstage output (see Chapter 1).

- Put the holding current switch to position 0 (+ / 0 / - switch, #25). If you use a cell model, only the C_{EL} and GND connectors must be connected.
- Set the MODE OF OPERATION switch to OFF.

Important: The tuning procedure **must not** be done in VC mode!!

- Connect the CURR.EL connector of the current headstage to ground. If parasitic oscillations occur use a 10 k Ω resistor for grounding. If you use a cell model set the ON / GND switch to GND.
- Switch the upper digital display (#10) to CURRENT ELECTRODE (potential output of the current electrode) using the electrode selector POTENTIAL (#7). Set the reading of the display to 0 using the potentiometer CURRENT ELECTRODE OFFSET (#16).
- After tuning the current electrode potential OFFSET connect the cell model (see chapter 7.2). If you do not use a cell model simulate an electrode by replacing the 10 k Ω resistor with a much larger resistor (min. 5-10 M Ω).
- The digital display (and the CURRENT ELECTRODE potential connector (C_{EL} x10mV) (#32)) now shows a voltage deflection that is related to the BIAS current of the headstage according to Ohm's Law. Cancel this voltage by tuning the headstage C. HEADSTAGE BIAS CURRENT potentiometer (#17). The current is 0 if the voltage deflection is 0.

Now all current outputs (CURRENT OUTPUT FROM HEADSTAGE(#24), CURRENT OUTPUT (#26) and the CURRENT DISPLAY (#9) should also read 0.

8.2. Offset Compensation

If an electrode is immersed into the bath solution an offset voltage will appear, even if no current is passed. This offset potential is the sum of various effects at the tip of the electrode filled with electrolyte (“tip potential”, junction potential etc.). This offset voltage must be compensated i.e. set to 0 carefully with the OFFSET controls (#16 and #18) before recording from a cell. The OFFSET compensation is done in CC mode of the amplifier. When adjusting the OFFSETs make sure that no current flows through the electrodes. Thus, it is recommended to disconnect COMMAND INPUT (#31) and to disable the HOLD unit (see chapter 4.2).

Potential Electrode

- Switch the reading of the upper digital display (#10) to POTENTIAL ELECTRODE using the electrode selector POTENTIAL (#7). The display (#10) shows the potential of the potential electrode in XXX mV.
- Compensate the OFFSET with the POTENTIAL OFFSET (#18) potentiometer.

Current Electrode

- Switch the reading of the upper digital display (#10) to CURRENT ELECTRODE using the electrode selector POTENTIAL (#7). The display (#10) shows the potential of the current electrode in XXX mV.
- Compensate the OFFSET with the CURRENT ELECTRODE OFFSET (#16) potentiometer.

Note: If a cell model is connected the OFFSET controls should read values around 5, otherwise it is likely that the headstages or the amplifier are damaged. If microelectrodes are used unusual high OFFSETs are a sign of badly chlorinated silver wires or unwanted grounding of the bath.

8.3. Electrode Resistance Test

The electrode resistance is dependent on the tip diameter of the electrodes and may reveal whether electrodes are broken or clogged. Therefore, a resistance measurement test for both microelectrodes is included in the TEC-03X. The test operates independently of any other adjustments, assuming that all microelectrodes are in contact with a grounded bath (zero potential). The measured resistance is independent of tip potentials and is automatically displayed on the upper digital display in MΩ. Furthermore, the electrode resistance can be tested even if the electrode is inside a cell!

The measurement is performed by applying square current pulses of ±10 nA to the respective microelectrode. The voltage deflection caused by this injection is recorded and processed to give a direct reading in MΩ on the digital display.

Important: The electrode resistance test is also a test of the correct function of the respective headstage.

The resistance test gives only a rough estimate of the electrode resistance. The value for the current electrode is dependent on the calibration of the current headstage (see chapter 5.2) and the reading is correct only in position x1.

Potential Electrode

- ❑ Set the ELECTRODE RESISTANCE (#13) switch to POTENTIAL ELECTRODE. The display (#10) shows the resistance of the potential electrode in XX.X M Ω .

Current Electrode

- ❑ Set the ELECTRODE RESISTANCE (#13) switch to CURRENT ELECTRODE. The upper digital display (#10) shows the resistance of the current electrode in XX.X M Ω .

Important: Since the amplitude of the current pulses is relatively small (at least for oocytes) the electrode resistance can be checked even if the electrode is inside the cell!

8.4. Capacity Compensation

The frequency response of the potential electrode (low-pass characteristic due to stray capacities) is compensated for by a feedback circuit ("negative capacity" compensation, CAPACITY COMPENSATION) and a "driven-shield" arrangement (for an overview see Ogden 1994). Since in oocyte experiments microelectrodes are usually in the one M Ω range or below for most experiments it is not required to use the CAPACITY COMPENSATION.

The tuning of the capacity compensation control is performed using pulses applied to the COMMAND INPUT or pulses provided by the electrode resistance test circuit. The TEC-03X has to be in CC mode (see chapter 8.5).

With the cell model connected or the electrode in the bath the CAPACITY COMPENSATION control is turned clockwise until there is no artifact on the POTENTIAL OUTPUT P_{EL}.

Important: Capacity compensation is based on positive feedback. Therefore over-compensation causes oscillations which can damage the preparation or the recording electrodes. Therefore the control must be handled with care and before impaling a new cell it must be set to 0.

8.5. Testing Operation Modes

Current Clamp

The cell's response to current injections is measured in the current clamp (CC) mode. Current injection is performed by means of a current source connected to the current injecting microelectrode.

- Set the amplifier to CC mode using the MODE OF OPERATION switch (#28).
- If not already done tune the BIAS current to 0 (see chapter 8.1).
- Set the CURRENT OUTPUT SENSITIVITY (#15) to 1.
- Compensate the offsets of the current- and voltage electrode (see chapter 8.2).
- Set R_m at the cell model to 10k (see chapter 7).
- Set the holding current to $-1 \mu\text{A}$ using the HOLD potentiometer (#12) (setting: 100, reading: $-1.00 \mu\text{A}$) and the HOLD current polarity switch (#25) (set to -).
- Make sure that the potential switch (#7) is set to POTENTIAL electrode and the ELECTRODE RESISTANCE test is not active.
- The POTENTIAL display should read -10 mV (according to Ohm's law). The voltage at P_{EL} (#33) should be -100 mV .

Remember: The voltage at P_{EL} is the membrane potential multiplied by 10!

- Disable the holding current and apply a test pulse of $2 \mu\text{A}$ to the cell model by giving a voltage step of 2 V to COMMAND INPUT (#31). The length of the test pulse should be at least 50 ms.
- You should see a potential step of 200 mV amplitude at P_{EL} (#33). Due to the membrane capacity the step is smoothed.

Note: If you expect the POTENTIAL display to show the value of the potential step (in this case 20 mV amplitude) remember that the display is rather sluggish and may not display the right value (depending on the length of the step). The same is true for the CURRENT display.

Voltage Clamp

In voltage clamp mode, the membrane potential is forced by a controller to maintain a certain value or to follow an external command. That allows measurement of ion fluxes across the cell membrane. This is the most complex mode of operation with the TEC-03X. Special precautions must be taken while tuning the control circuit in order avoid stability problems.

- Make sure that the amplifier works correctly with the cell model in CC mode (see above).
- Set the holding potential to -50 mV using the HOLD potentiometer (#12, setting: 050, reading: 050 mV) and the HOLD potential polarity switch (#25, set to -).

Remember: The HOLDING potentiometer sets the holding current in CC mode and the holding potential in VC mode.

- Set the control mode switch (#6) to NORMAL, GAIN ONLY.
- Set the CAPACITY COMPENSATION to 0 and the GAIN (#5) to 1.

- ❑ Enable the OSCILLATION SHUTOFF unit with a moderate THRESHOLD (DISABLED / RESET switch (#2) in middle position, OSCILLATION SHUTOFF LED green, THRESHOLD potentiometer set to a low value, but not to the most left position)
- ❑ Set the amplifier with the MODE OF OPERATION switch (#28) to VC mode.
- ❑ The upper display should show the holding potential of -50 mV and the lower display the holding current of -5 μ A (according to Ohm's law).

It is very likely that the display shows a holding potential of slightly less than -50 mV because the controller is in NORMAL, GAIN ONLY mode (see also Appendix, chapter 12) and the GAIN is low. Increasing GAIN and setting the controller to SLOW (Integrator) mode will enhance the control loop and therefore increase accuracy.

Hint: If the system oscillates as soon as you switch to VC mode switch back to CC mode and check the settings. GAIN too high? CAPACITY COMPENSATION not 0? THRESHOLD potentiometer of the OSCILLATION SHUTOFF unit at the most left position? Control mode switch not to NORMAL, GAIN ONLY or SLOW (Integrator)?

- ❑ Apply a test pulse of 20 mV to the cell model by giving a voltage step of 0.2 V to COMMAND INPUT (#31). The length of the test pulse should be at least 30 ms.
- ❑ You should see a potential step of 200 mV amplitude at P_{EL} (#33).

Note: If you expect the POTENTIAL display to show the value of the potential step (in this case +20 mV amplitude, i.e. -30 mV) remember that the display is rather sluggish and may not display the right value (depending on the length of the step). The same is true for the CURRENT display.

8.6. Tuning the VC mode

In VC mode there is the problem that the voltage step is often not strictly angular shaped. But, for instance, increasing the clamp speed by tuning the CAPACITY COMPENSATION of the potential electrode or increasing GAIN also increases noise. Therefore, the settings of the different parameters result always in a compromise between the stability, accuracy, noise and control speed. In this chapter we will give some practical hints, how to optimize the accuracy and speed of the clamp. The theoretical background of adjustment criteria is discussed in chapter 12 (see also Polder and Swandulla, 2001).

The main considerations are: Do I expect rapid or slow responses to voltage changes? How much noise can I accept? Is it possible to use electrodes with low resistance?

General: The speed and accuracy of the voltage clamp control circuit is mainly determined by the question how much current can be injected and how fast can this happen. Thus, the more current the system can inject within a short time the better the quality of the clamp (see chapter 12).

General Considerations

The key to accurate and fast recording is a properly built setup.

- Make sure that the internal system ground is connected to only one point on the measuring ground and originates from the potential headstage. Multiple grounding

should be avoided; all ground points should originate from a central point. The electrode used for grounding the bath should have a low resistance so that it can pass large currents.

- Use electrodes with resistances as low as possible.
- Keep cables short.
- Use differential potential recording (see also chapter 5.1 and Figure 10).
- Check regularly whether cables and / or connections are broken.
- Make sure that chloriding of silver wires for the electrodes is proper and that there are no unwanted earth bridges, e.g. salt bridges originating from experimental solutions.

Only if no intracellular series resistance is considered TEC system can be tuned according to one of three optimization methods (see also chapter 12):

1. the "linear optimum" (LO) that provides only slow response to a command step and a maximal accuracy of 90-97%.
2. the "absolute value optimum" (AVO) that provides the fastest response to a command step with very little overshoot (maximum 4%) or
3. the "symmetrical optimum" (SO) has the best performance compensating intrinsic disturbance signals but shows a considerable overshoot (maximum 43%) to a step command.

Under consideration of an existing intracellular series resistance these methods cannot be applied. Instead, a series resistance compensation can be introduced to optimize clamp performance (see also chapter 12.2).

Three control modes are implemented to adapt the TEC-03X to the needs of the user:

1. **NORMAL** fits to many users. In this mode a good compromise between speed, accuracy, noise and stability is achieved. The normal mode can be optimized by the LO method (see above).
2. **SLOW** for relative slow recordings (e.g. ligand activated currents). In this mode accuracy and stability are increased while speed is decreased. Optimization is done according to the AVO- or SO method (see above).
3. **FAST** for very fast recordings (e.g. fast voltage activated currents). In this mode speed and accuracy are increased but the system is very sensitive with a higher noise level and tuning requires more experience. Optimization is done by adjusting the amount of current proportional gain of the **SERIES RESISTANCE COMPENSATION** and optimal positioning of the electrodes (see chapter 9).







Important: First use a cell model for the tuning procedure. You will get familiar with the different settings and the consequences for the system without any damage to cells or electrodes.

Tuning Procedure

- ❑ Before you switch to VC mode tune all parameters related to the recording electrodes (offset, capacity compensation etc.) in CC mode, set GAIN to a low, save level and the control mode switch to NORMAL, GAIN ONLY (see chapter 8.5). Activate the OSCILLATION SHUTOFF unit!
- ❑ Switch to VC mode and apply identical test pulses to the cell model.
- ❑ The controller is now in P-mode (proportional only). Watch the potential output and increase the GAIN so that no overshoot appears.

If you are working on slow currents

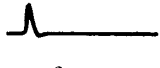
- ❑ Switch the control mode switch to SLOW, INTEGRATION to activate the integrator. The controller is now in PI-mode (proportional-integral). Tune the GAIN again (see above).
- ❑ Watch the potential output and tune the time constant until the overshoot of the desired tuning method appears (see also Figure 14).

	Response to a command variable step	Response to a disturbance variable step
Linear optimum LO (aperiodic response) P-Controller	 slow response no overshoot	 slow response large deviation
Absolute value optimum AVO PI-Controller	 fastest response 4% overshoot	 slow response slight deviation
Symmetrical optimum SO Unsmoothed command variable PI-Controller	 fast response 43% overshoot	 very fast response slight deviation
Smoothed command variable	 slow response 8% overshoot	

LO

Only a P-Controller is used. The response to a command step is slow and has no overshoot (potential output). The response to a disturbance e.g. an activating channel is slow and has a large deviation.

AVO

A PI-Controller is used. The response to a command step is very fast with 4% overshoot (potential output). The response to a disturbance e.g. an activating channel is slow and has a slight deviation.

SO

A PI-Controller is used. The response to an unsmoothed command step is fast with 43% overshoot (potential output). The response to a disturbance e.g. an activating channel is very fast and has a slight deviation.

Figure 14: tuning VC according LO, AVO or SO. The potential output is shown.

If you are working on very fast currents

- ❑ Lower the GAIN by approximately 10%.
- ❑ Switch the control mode switch to FAST, SERIES RESISTANCE COMPENSATION to activate the series resistance compensation. Rise the amount of SERIES RESISTANCE COMPENSATION and watch the current output. The capacitive transient seen on the current trace should be mono-exponential. The critical compensation is achieved when the slow tail of the transient disappears. If you see ringing around the slow tail this is a sign that the electrodes are not optimally positioned (see also chapter 9).

Hint: SERIES RESISTANCE COMPENSATION is done by positive feedback in the control circuit, which can lead very quickly to stability problems. Repositioning the electrodes is recommended whenever possible instead of extensive use of SERIES RESISTANCE COMPENSATION (see also chapter 9).

Note: With a standard cell model described in chapter 7 you cannot verify the advantages of the FAST mode (because no series resistance is simulated). Ask npf for a modified cell model with series resistance simulation.

Details of how to tune PI controllers and some theoretical aspects are described in chapter 12.2.

8.7. Installing and Testing a Data Acquisition Board from National Instruments

The following procedure is related to installation of E-series and B-series data acquisition hardware using NI-DAQ 6.9.3. Newer DAQ versions and M-series boards have a slightly different MAX user interface. Please contact npielectronic if you encounter problems in installation data acquisition hardware with the TEC-03X-CW.

Basic Test of INT-20X and Data Acquisition board.

- ❑ Disconnect the INT-20X from all devices including multifunction I/O board from NI.
- ❑ Test connection between digital ground and analog ground. Measure at the shields of the respective BNCs (Ai and Do respectively) and at the banana plugs (AGND and DGND respectively). The grounds should not be connected. The resistance between AGND and the Ai channels should be around 1 M Ω . The resistance between DGND and the Do channels should be around 250 Ω .
- ❑ Connect the NI board to the INT-20X (but no other devices). Prove the ground connections again. All BNC shields and ground plugs should now be connected and should have connections to the ground at the computer. Check this by connecting AGND to a metal screw of the computer housing.
- ❑ Check the resistance between Ai channels and AGND. The resistance must be 1 M Ω . If not check if there is voltage at the Ai channel (normally there should be no voltage).

The TURBO TEC-03X-CW is designed to work with data acquisition boards from National Instruments (NI).

The installation process of a data acquisition board from NI is carried out in two steps (detailed information is given in the CellWorks “Short_Manual_5.1” and in the User Manual of the respective NI board). Briefly (for PC):

1. *Software installation:* This has to be performed **prior** to the hardware installation. The setup routine from NI installs the driver for the data acquisition board and a program called MAX (Measurement & Automation Explorer). Once the software is installed a reboot is required and the computer has to be shut down to install the hardware.
2. *Hardware installation:* Find a free PCI slot, install the NI board and start the operating system. The NI board will be recognized automatically and the driver is configured with the configuration dialog that starts. Now, the computer is ready to measure data with CellWorks.

The NI program MAX is a tool for configuring and testing data acquisition boards from NI. The following steps can be carried out to test some basic functions of the NI board independent of CellWorks and the TURBO TEC-03X-CW. Although the tests can be performed also without a breakout box we recommend using a breakout box for the tests because then you can really prove the in- and outputs.

Important: The NI board has to be configured in Unreferenced Single Ended mode with bipolar output and ± 10 V range (see Figure 15).

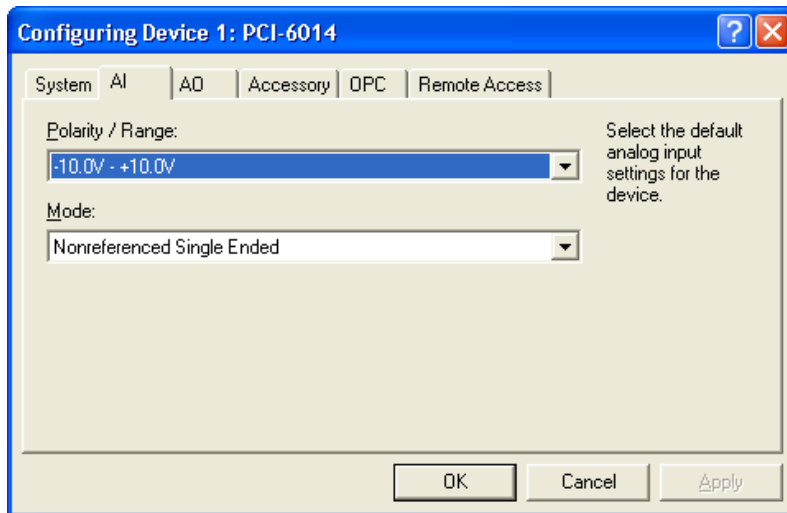

Figure 15: standard configuration of E-series and B-series boards

Test using a Breakout Box

- Connect the cable from the NI board directly to the breakout box. If you use a PCI-1200 connect the NI board **without** the CellWorks trigger dongle. This is important since otherwise the trigger dongle will interfere with the tests.
- Start MAX (there should be an icon of MAX on the Windows desktop).
- Click to “Devices and Interfaces“ in the left panel and select the board that you want to test.
- Launch the “Test-Panel”.

The Test-Panel consists of four sub-panels where analog in- and outputs, counter I/O and digital I/O ports can be tested (see Figure 16). First, the sub panel “Analog Input” appears.

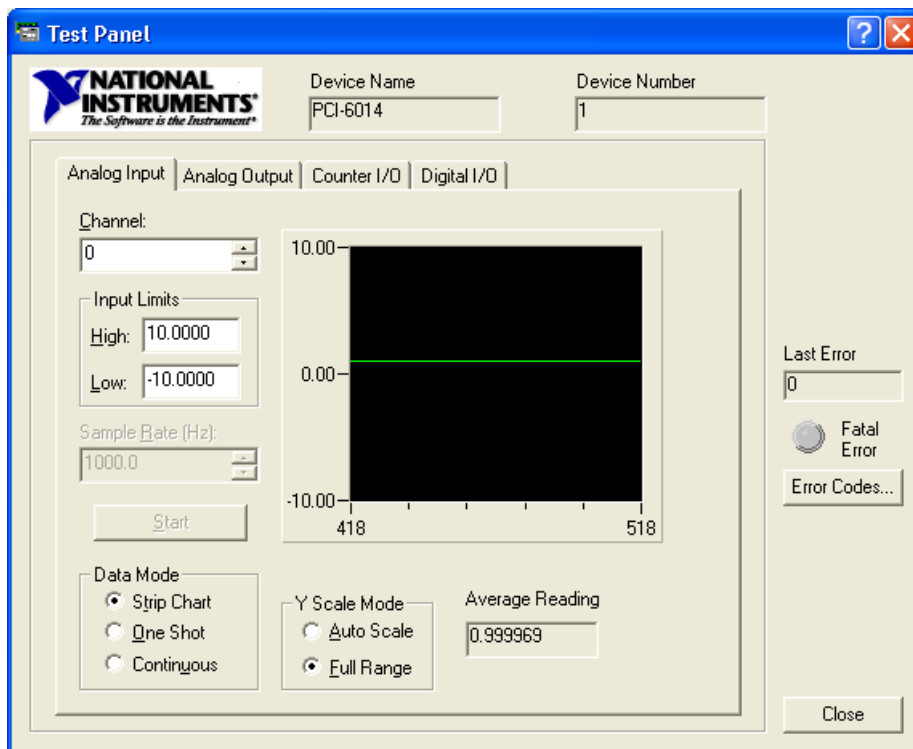

Figure 16: “Test-Panel” of MAX

- Leave Ai0 at the breakout box open and watch the panel in MAX. You should see some noise at the input.
 - Connect an external waveform to Ai0 of the breakout box and to an oscilloscope. The voltage range of the waveform should not exceed ± 10 V. Select “Channel 0” and you should see the external waveform on the screen. The waveform on the screen and the oscilloscope should be identical.
 - Perform this test with all other analog inputs.
 - Go to “Analog Output” and connect an oscilloscope to DAC0 of the breakout box. As “Output Mode” select “Sine Generator” and as “Channel Selection” select “0”. Start the sine generator and watch the output at the oscilloscope.
 - Test analog out channel 1 (DAC1) in the same way.
-
- Go to “Counter I/O” and keep the default values. Start the test with “GPCTR0”. The green button in the field “Counter-Status” indicates that counter 0 works well.
 - Test counter 1 accordingly.

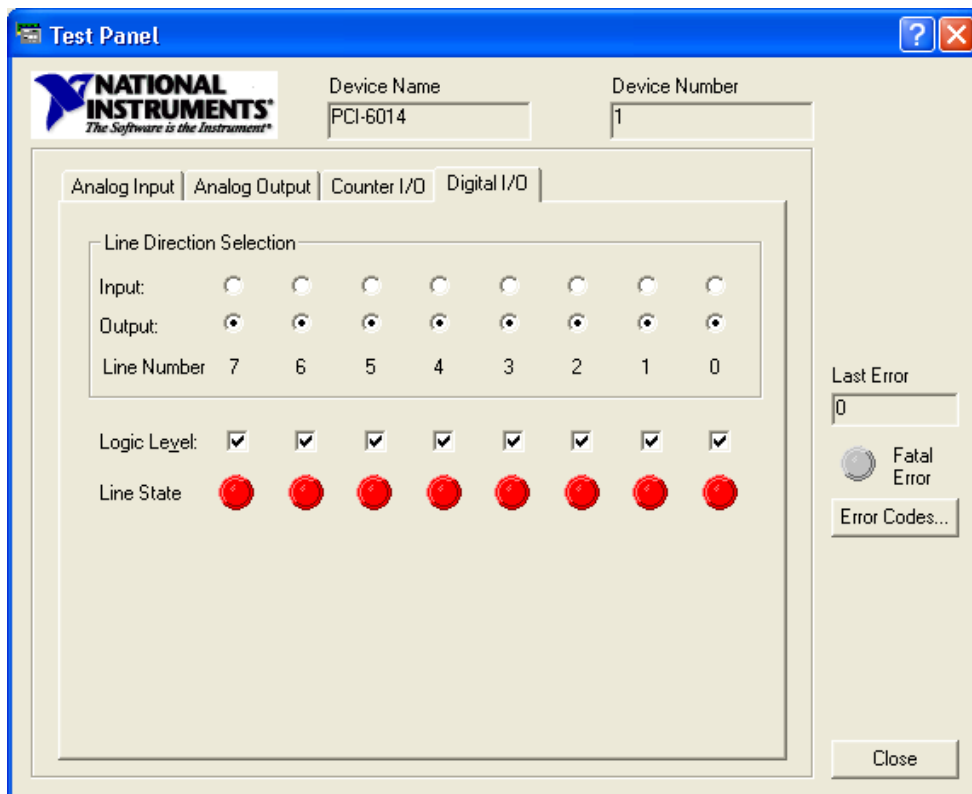

Figure 17: testing digital I/O ports using MAX

- Launch “Digital I/O” and activate all outputs by clicking “Output” for every channel. You can switch the logical level, i.e. high or low, of every individual channel by clicking “Logic Level”. In Figure 17 all channels are high. You can prove this by connecting a digital multimeter or an oscilloscope to the digital outputs of the breakout box.

Note: Every sub-panel shows on the right side of the window a field named “Last Error” and a dot named “Fatal Error”. If the dot is red an error had occurred during the last test, and a number appears in the field “Last Error”. Click the button “Error Codes” to open a window with explanations about this error code.

Test without a Breakout Box

- Disconnect the NI board from all peripherals. This is important since otherwise the peripherals may interfere with the tests.
- Start MAX (there should be an icon of MAX on the Windows desktop).
- Click to “Devices and Interfaces “ and select the board you want to test.
- Launch the “Test-Panel“.

The Test-Panel consists of four sub-panels where analog in- and outputs, counter I/O and digital I/O ports can be tested (see Figure 16).

- The test panel in “Analog Input” should show some noise.
- Go to all of the sub-panels and perform as many tests as possible. Watch the status dots that prove the function of the respective task.

Note: Every sub-panel shows on the right side of the window a field named “Last Error” and a dot named “Fatal Error”. If the dot is red an error had occurred during the last test, and a number appears in the field “Last Error”. Click the button “Error Codes” to open a window with explanations about this error code.

9. Positioning of Electrodes

The position of the electrodes plays an important role in tuning the clamp speed. The position of the current electrode is especially crucial for homogeneous charging of the membrane capacitance, one limiting factor of clamp speed. If the current electrode is placed just at the edge of the oocyte, i.e. with a small penetration depth, the part of the membrane close to the electrode will be charged more quickly than the membrane at the other side of the oocyte. Thus, the voltage controlled by the clamp is different. This leads to a capacitive transient with a slow tail (see Figure 18, right side). Placing the current electrode central in the oocytes i.e. with a large penetration depth, leads to a homogeneous charging of the membrane. In this case the capacitive transient can be kept short by critical compensating R_s (see Figure 18, left side).

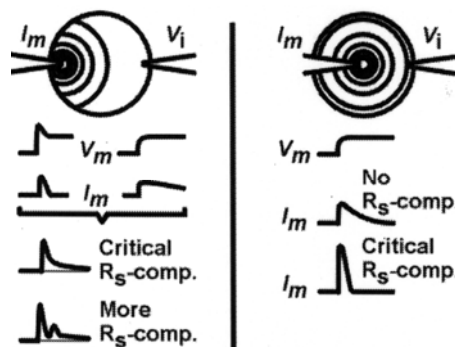

Figure 18: penetration depth of the current electrode and consequences for the clamp

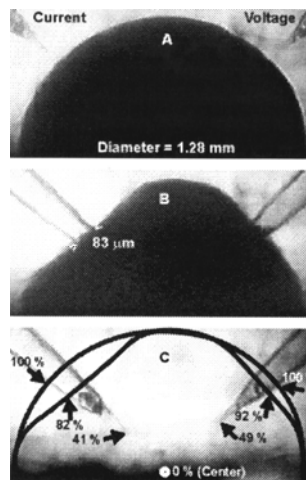

Figure 19: demonstration of electrode positioning

Figure 19 shows the side view of positioning the electrodes in a sequence of microphotographs. **A** shows the tips coming from 45° from above just before touching the oocyte and **B** the electrodes in their final position. The reconstruction in **C** gives the position relative to the center of the oocyte.

Figures are kindly provided by Nikolaus G. Greeff (Greeff, 2000).

10. Sample Experiment

In the following the basics of a simple experiment are described. It is assumed that all connections are built as described in chapter 6. Before starting remove the cell model.

Again: It is of major importance that the TEC-03X systems are used only in warmed-up condition i.e. 20 to 30 minutes after turning power on.

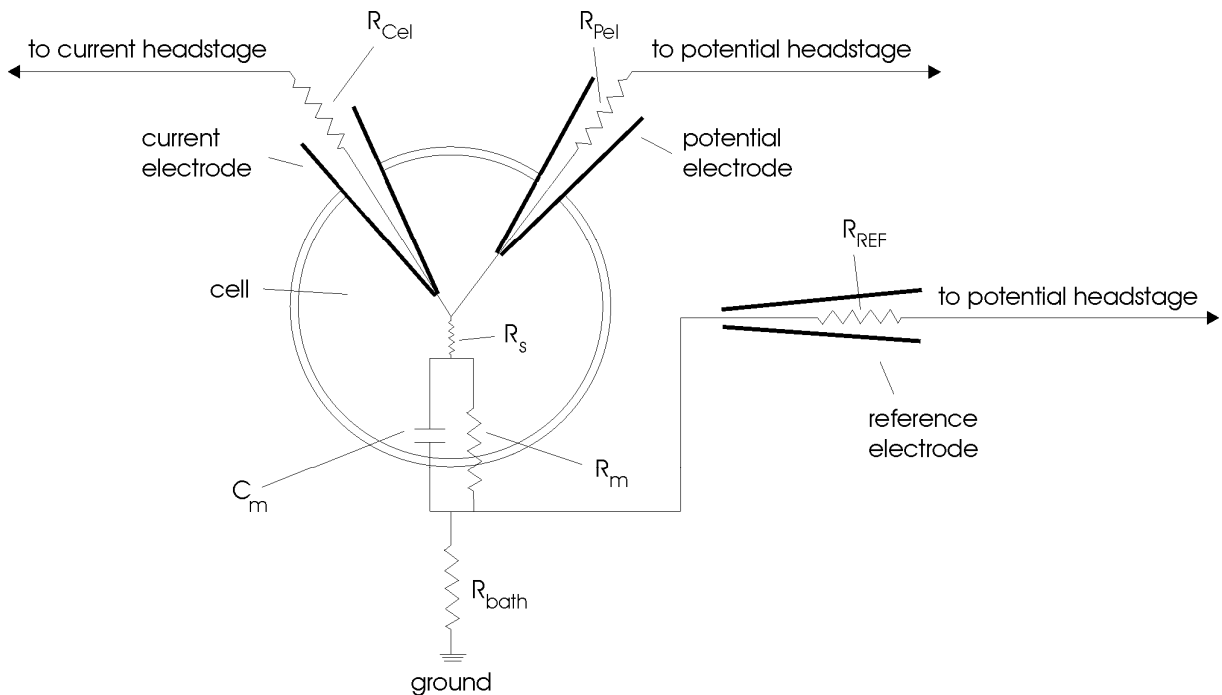

Figure 20: model circuit for voltage clamp recording from a cell, e.g. an oocyte using low-resistance electrodes

C_m : membrane capacity, R_m : membrane resistance, R_{CEL} : current electrode resistance, R_{PEL} : potential electrode resistance, R_{REF} : reference electrode resistance, R_s : series resistance

- Adjust BIAS CURRENT to 0 if necessary (see chapter 8.1).
- Turn off the amplifier!
- Reconnect the COMMAND INPUT.
- Connect the Ag-AgCl pellet or the agar-bridge for grounding the bath with GND at the potential headstage.
- Connect the reference electrode to REF. at the potential headstage.
- Insert potential- and current electrode into the electrode holders. Check if the silver wires of both electrodes are well chlorided and in contact with the electrode solution, and connect them to the respective headstages.
- Immerse both electrodes into the bath and make the basic settings (see chapter 6).
- Turn on the amplifier.

- ❑ Compensate the potential offset (for both electrodes, see chapter 8.2), measure the electrode resistance (for both electrodes, see chapter 8.3). The resistances should be 700 k Ω to 1-2 M Ω for the potential electrode and 500 k Ω to 1 M Ω for the current electrode. As mentioned above, it is usually not necessary to compensate for the electrode capacity (for the potential electrode, see chapter 8.4).
- ❑ Set the upper display to POTENTIAL ELECTRODE.
- ❑ Insert the potential electrode into the oocyte. The potential electrode is inside the cell if you read a membrane potential of about -50 mV to -60 mV. It's a good idea to activate the audio monitor. Then you can look through the microscope while hearing the membrane potential.

Remember: The membrane potential of the oocyte is strongly dependent on the condition of the oocyte (leaky or not), the experimental solutions and the membrane proteins (channels/transporters) that are expressed.

- ❑ If your reference electrode can be moved place it near the cell membrane and the potential electrode to optimize differential potential recording.
- ❑ Insert the current electrode into the oocyte. There are two indications that the current electrode is inside the cell:
 - If you apply a test current pulse to the cell, the potential read by the potential electrode changes according to Ohm's law.
 - If you switch the POTENTIAL display to CURRENT ELECTRODE (see chapter 8.2) you read the same membrane potential as read by the potential electrode.
- ❑ After penetration with both electrodes the voltage responses of the cell to the test pulses in CC mode should reflect the cell membrane resistance and time constant.
- ❑ Start the experiment.
- ❑ If you intend to work in VC mode tune the system in CC mode, then switch to VC mode and adjust the clamp as described in chapter 8.6.

11. Trouble Shooting

In the following section some common problems, possible reasons and their solutions are described.

Important: Please note that the suggestions for solving the problems are only hints and may not work. In a complex setup it is impossible to analyze problems without knowing details. In case of trouble always contact an experienced electrophysiologist in your laboratory if possible and connect a cell model to see whether the problem occurring with electrodes and “real” cells persists with the cell model.

Problem 1:

After immersing an electrode into the bath there is an unusual high potential offset.

Possible reasons:

1. The Ag-AgCl coating of the silver wire in the electrode holder is damaged
2. The Ag-AgCl pellet or Ag-AgCl coating of the silver wire in the agar-bridge are damaged
3. There is an unwanted GND-bridge e.g. caused by a leaky bath
4. The headstage or the amplifier has an error

Solutions:

1. Chloride the silver wire again
2. Exchange the pellet or chloride the silver wire in the agar-bridge
3. Try to find the GND-bridge and disconnect it e.g. by sealing the bath
4. Contact npj

Problem 2:

Even if no stimulus is given a current flows through the current electrode

Possible reason:

1. The BIAS current is not adjusted

Solution:

1. Adjust the BIAS current according the procedure described in chapter 8.1

Problem 3:

The system oscillates (see also *voltage clamp* in chapter 8.5)

Possible reason:

1. The capacitance of the electrode is overcompensated
2. There is too much series resistance compensation

Solution:

1. Turn the CAPACITY COMPENSATION potentiometer (#30, Figure 3) to the most left position and compensate the input capacitance again
2. Turn the SERIES RESISTANCE COMPENSATION potentiometer (#4, Figure 3) to a lower value

Problem 4:

With the cell model connected the R_{EL} display does not show the correct value (within a tolerance of 2%).

Possible reason:

1. The headstage has an error

Solution:

1. Contact npj

12. Appendix

12.1. Theory of Operation

The standard configuration for voltage clamping oocytes is the two electrode voltage clamp arrangement (Stühmer, 1992; Stühmer et al. 1992; Dietzel et al., 1992; Stühmer, 1998). In contrast to previously described clamp systems (for review see Smith et al., 1985) the amplifiers for oocyte clamping must meet special requirements since oocytes are very large cells with a high membrane capacity (up to 100-500 nF) and large membrane currents (up to 100 μ A and more).

Voltage clamp instruments are closed loop control systems with two inputs external to the control loop. An electronic feedback network is used to force the membrane potential of a cell to follow a voltage command (setpoint input) as fast and as accurately as possible in the presence of incoming disturbances (disturbance input, correlated with the activities of the cell e.g. activation of ion channels). This is achieved by injecting an adequate amount of charge into the cell. The current injected by the clamp instrument is a direct measure of the ionic fluxes across the membrane (Ferreira et al., 1985; Jack et al., 1975; Ogden, 1994; Smith et al., 1985).

The performance evaluation and optimal tuning of these systems can be done by considering only the command input since the mathematical models (set point transfer function and the disturbance transfer function, see Froehr, 1985; Polder; 1984; Polder and Swandulla, 1990; Polder, 1993; Polder and Houamed, 1994; Polder and Swandulla, 2001) are closely related. Modern control theory provides adequate solutions for the design and the optimal tuning of feedback systems (Froehr, 1985).

Most voltage clamp systems are composed only of delay elements, i.e. elements which react with a retardation to a change. This type of closed loop systems can be optimized easily by adequate shaping of the "frequency characteristic magnitude" ($|F(j\omega)|$) of the associated transfer function $F(s)$ (output to input ratio in the frequency domain = **LAPLACE** transform of the differential equation of the system, Polder and Swandulla, 2001).

Using controllers with a proportional-integral characteristic (PI-controllers) it is possible to force the magnitude of the frequency characteristic to be as close as possible to one over a wide frequency range ("modulus hugging", see Froehr, 1985; Polder; 1984; Polder and Swandulla, 1990; Polder, 1993; Polder and Houamed, 1994; Polder and Swandulla, 2001). For voltage clamps this means that the controlled membrane potential rapidly reaches the desired command value.

The PI-controller yields an instantaneous fast response to changes (proportional gain) while the integral part increases the accuracy by raising the gain below the corner frequency of the integrator (i.e. for slow signals) to very high values (theoretically to infinite for DC signals, i.e. an error of 0%) without affecting the noise level and stability. Since the integrator induces a 0 in the transfer function, the clamp system will tend to overshoot if a step command is used. Therefore the tuning of the controller is performed following optimization rules which yield a well defined system performance (AVO and SO, see below).

The various components of the clamp feedback electronics can be described as first or second order delay elements with time constants in the range of microseconds. The cell capacity can

be treated as an integrating element with a time constant T_m which is always in the range of hundreds of milliseconds.

Compared to this "physiological" time constant the "electronic" time constants of the feedback loop can be considered as "small" and added to an equivalent time constant T_e . The ratio of the "small" and the "large" time constant determines the maximum gain which can be achieved without oscillations and thus, the accuracy of the clamp. With the gain adjusted to this level the integrator time constant and "small" time constant determine the speed of response of the system.

The clamp performance can be increased considerably if the influence of the current injecting electrode is excluded as far as possible from the clamp loop since the electrode resistance is nonlinear. This is achieved if the output of the clamp system is a current source rather than a voltage source. In this case the clamp transfer function has the magnitude of a conductance (A/V). Other advantages of this arrangement are that the clamp current can be determined by a differential amplifier (with no need of virtual ground, see Greeff and Polder, 1997; Polder and Houamed, 1994) and that the bandwidth of the feedback system can be altered easily (e.g. for noise suppression during simultaneous patch clamp recordings, see Stühmer, 1992; Stühmer et al. 1992; Stühmer and Parekh, 1995).

This output circuit is equipped with large bandwidth high voltage operational amplifiers. To avoid deterioration of clamp performance caused by electrode overload the output current has to be limited by an electronic circuit to a safe level. With electrodes in the range of one M Ω and a voltage of ± 150 V, the maximum current will be 150 μ A. With this current a cell with a capacity of 100 nF can be depolarized by 100 mV in approximately 100 μ s, which comes close to the theoretically possible speed of response, without any detectable deviations from the command level. With an output compliance of 225 V and a x2 or x5 range current injecting headstage, currents up to 500 μ A can be injected (see Greeff and Polder, 1997; Polder and Houamed, 1994).

The accuracy of a two electrode clamp system and the speed of response is determined by the cell capacity, the resistance of the current injecting microelectrode (that limits the maximum amount of injected current) and the equivalent time constant and accuracy of the potential recording and feedback electronic systems. Therefore, the design of the potential recording site is very important. A differential potential registration with a reference electrode that registers the bath potential minimizes errors due to resistances outside the cell in series with the cell membrane. Driven shield and capacity compensation circuits are used to improve the speed of response.

In some cases, a series resistance compensation circuit (for series resistance inside the cell) which adds a current proportional gain can improve the clamp performance considerably (Greeff and Polder, 1997; Greeff, 2000; Greeff and Kühn, 2000). The use of such a circuit enhances the speed of response and improves the accuracy of the clamp system. But the noise level is also increased because both circuits are positive feedback loops.

In addition to the elements of the clamp loop itself, this oocyte clamp amplifier has some additional units that facilitate experiments such as electrode resistance test units, oscillation shut-off unit, adequate output signal amplification, filtering and display units, facility for compensating capacitive currents, etc.

12.2. Tuning Procedures for VC Controllers

The initial settings (see *voltage clamp* in chapter 8.5) guarantee only a stable clamp that is not very accurate and insufficiently rapid for certain types of experiments, e.g. investigation of fast voltage-activated ion channels or gating currents. Thus, for successful and reliable experiments, it is necessary to tune the clamp loop.

Only if no intracellular series resistance is considered tuning of the clamp is performed according to optimization methods. It depends on the type of experiment to which method one should follow (see below).

- **“Linear Optimum” (LO)**

with this method only the proportional part of the PI controller is used. The response to a command step is slow, but produces no overshoot. The response to a disturbance is also slow with a large deviation of the membrane potential. Clamp accuracy is a maximum of 90-97% (Finkel and Redman, 1985). Therefore, this method should only be used only if it is very important to avoid overshoots of the membrane potential.

- **"Absolute Value Optimum" (AVO)**

uses the PI controller and provides the fastest response to a command step with very little overshoot (maximum 4%). The response to a disturbance is of moderate speed and the amplitude of the deviation is only half the amplitude obtained with LO. It is applied if maximum speed of response to a command step is desirable e.g. if large voltage activated currents are investigated.

- **"Symmetrical Optimum" (SO)**

uses also the PI controller and has the best performance compensating intrinsic disturbance signals. The response to a command step shows a very steep rise phase followed by a considerable overshoot (maximum 43%). The response to a disturbance is fast and the amplitude of the deviation is in the same range as with the AVO method. The overshoot can be reduced by adequate shaping of the command pulse by a delay unit (Froehr, 1985; Polder and Swandulla, 1990; Polder and Swandulla, 2001). This method is preferred for slowly activating currents, such as those evoked by agonist application.

The upper speed limit for all optimization methods is determined by the maximum amount of current which the clamp system can force through a given electrode (see chapter 12.3).

Practical Implications

In the following some practical implications of the theory discussed earlier in this chapter are outlined. It is assumed that you have read at least chapters 6 to 8, 12.1 and 12.2, that all connections are set up as described in chapter 6 and that the system is in VC mode with the initial settings described in chapter 8.5.

Although most of the parameters of the control chain are not known during an experiment it is possible to tune the clamp controller by optimizing the response to a test pulse applied to the COMMAND INPUT. The main criterion of tuning is the overshoot seen at the potential output. Since the SO method provides the tightest control it will be most sensitive to parameter settings and requires much experience.

Note: The transitions between the optimization methods are blurred and the tuning procedure is adapted to the experimental requirements. Often, the adequate tuning of a clamp system can be tested by specific test signals (e.g. stimulus evoked signals, etc.).

Very important: All parameters that influence clamp performance (microelectrode offsets, capacity compensation, etc.) must be optimally tuned before starting the PI controller tuning procedure (see chapter 8). Always activate the OSCILLATION SHUTOFF unit.

The tuning procedure involves the following steps:

Again: The main criterion of tuning is the amount of overshoot seen at the potential output.

Tuning of the proportional gain

- Set the voltage clamp control mode switch to NORMAL, GAIN only.
- Use the command input without smoothing and apply adequate, identical pulses to the cell (e.g. small hyperpolarizing pulses).
- The controller is in P-mode (proportional only). Watch the potential output and rise the GAIN so that no overshoot appears (LO method). The response to a command step is slow and has no overshoot (potential output). The response to a disturbance, e.g. synaptic input or an activating channel, is slow and has a large deviation.

Since the integral part of the controller is disconnected a steady state error in the range of a few percents will be present.

Tuning the integrator (SLOW mode)

- Reconnect the integrator to form the complete PI controller by setting the voltage clamp control mode switch to SLOW.
- Apply adequate test pulses without filtering.
- Adjust the integrator time constant (#4, Figure 3) to achieve the overshoot of the selected optimization method (4% with the AVO method and 43 % with the SO method). With the AVO method the response to a command step is very fast with 4% overshoot (potential output). The response to a disturbance, e.g. an activating channel is slow and has a slight deviation. With the SO method the response to an unsmoothed command step is fast with 43% overshoot (potential output). The response to a disturbance, e.g. an activating channel, is very fast and has a slight deviation.

Now the steady-state error must disappear.

Note: If the SO is used, an external command input filter can be used to smooth the command signal and consequently reduce the overshoot according to the requirements of the experiment (see also Figure 14).

Tuning the series resistance compensation (FAST mode)

The optimization methods mentioned above cannot be applied if series resistance is present and has to be considered.

Generally, the upper speed limit for all optimization methods is determined by the maximum amount of current which the clamp system can force through a given electrode. In experimental situations where very high clamp speed is desirable (e.g. recording of gating currents), the clamp speed can be improved additionally by optimizing the position of the electrodes and using SERIES RESISTANCE COMPENSATION (see also Greeff and Polder, 1998; Greeff and Kühn, 2000).

Since SERIES RESISTANCE COMPENSATION is done by positive feedback in the control circuit, its use can lead very quickly to stability problems. Therefore, the clamp speed should be improved first through conventional methods.

The optimal positioning of the electrodes, especially of the current electrode is important for best SERIES RESISTANCE COMPENSATION (see also chapter 9). By placing the electrode in the center of the oocyte, the membrane capacity is charged homogeneously. The capacitive current transient is mono-exponential and the amplifier can be tuned without ringing around the slow tail of the transient (Greeff, 2000).

- Before the experiment make sure that the electrodes are in optimal position (see Figure 19). If you have a micromanipulator that can remember positions you can first position the electrodes without the oocyte. Then the position is saved and the electrodes are drawn back, the oocyte is placed and the electrodes are brought back into the saved position.

- Set the voltage clamp control mode switch to FAST.
- Apply adequate test pulses without filtering.
- Tune the amount of SERIES RESISTANCE COMPENSATION (#4, Figure 3), while watching the current output. The capacitive transient of the current should show a mono-exponential decay. Overcompensation is indicated by a ringing after the first peak of the capacitive transient (see also Figure 18 in chapter 9, left side). This is also a sign that electrode position is not optimal.

12.3. Speed of Response and Linearity of the Capacitive Transients

For the investigation of voltage activated channels with voltage clamp instruments, some special techniques for eliminating the capacitive and leak currents have been introduced, such as the P/4 or more general P/N protocol (see Rudy and Iverson, 1992 for overview). For these protocols the speed and linearity of response of the clamp system is of great importance.

As outlined in chapter 12.1 the TEC systems are designed following a control theory procedure called "modulus hugging" (see Froehr, 1985; Polder, 1984; Polder and Swandulla, 1990, Polder and Swandulla, 2001). The procedure requires a PI (proportional-integral) controller. This procedure is applicable to control systems composed of an element with one "large" time constant T_m and many "small" time constants T_i . These "small" time constants can be added to an "equivalent" time constant T_e .

In case of the TEC control chain the "large" time constant is formed by the time constant of the cell membrane (several hundred of milliseconds) and the sum of "small" time constants resulting from the microelectrodes and the electronics (a few ten microseconds).

Note: Here only the proportional part of the PI controller is considered. Possible improvement of clamp performance due to series resistance compensation (see Ogden, 1994; Smith et al., 1990, Greeff, 2000; Greeff and Kühn, 2000 for details) is not considered.

General Considerations

For the TEC systems the "small" time constants are at least two orders of magnitude below the "large" time constant: The "large" time constant is the time constant of the membrane and the equivalent time constant is composed of the time constants of the electrodes, amplifiers etc.

$$T_m = R_m * C_m, T_e = \Sigma T_i \quad \text{with}$$

T_m = "large time constant"

R_m = membrane resistance

C_m = membrane capacity

T_e = "equivalent" time constant

T_i = "small" time constant

The performance of a clamp system can be improved if a voltage controlled current source is used for the current injecting electrode. In this case, the very large time constant (hundreds of milliseconds) formed by the electrode resistance and the cell capacity can be ignored, because the output of the clamp circuit is a current that flows regardless of the resistance of the injecting microelectrode (Smith et al., 1990). Thus, the performance of the clamp is no longer dependent on the electrode resistance (as long as the current source is not saturated). In this case the clamp gain has the magnitude of a conductance [A/V].

The proportional gain of the clamp system can be calculated as follows (Froehr, 1985; Polder, 1984):

$$K = C_m / 4 * T_e \quad \text{Linear optimum (LO), aperiodic response, no overshoot}$$

$$K = C_m / 2 * T_e \quad \text{Modulus optimum (MO or AVO, respectively), 4\% overshoot, fastest rise time}$$

The optimal gain for a VC experiment is in between these two values. The overshoot can be reduced by low-pass filtering of the command pulse.

The speed of response of the clamp in case of the modulus optimum can be calculated as:

$$T_r = 4.7 * T_e, T_s = 8.4 * T_e \quad \text{with}$$

T_r - time until the membrane potential reaches for the first time 100% of the command pulse

T_s - time to reach steady state within a tolerance of 2%.

T_s is roughly the duration of the capacitive transient. For a system with dampened overshoot T_r approaches T_s .

From these formulas, it is clear that the performance of the clamp is determined by T_e . T_e is determined by the time constant of the current injecting electrode i.e. by the electrode resistance, stray capacities, cable capacities etc. Shielded cables have capacities of 60 - 110 pF/m, connectors and pipette holders add a few picofarads. The potential electrode is equipped with a driven shield and a capacity compensation circuit. Therefore, this time constant is always much smaller than the time constant associated with the current electrode. The time constants of the operational amplifiers are small and can be neglected.

Example

A cable of 10 cm has a capacity of approximately 10 pF, with the stray capacities in the headstage and an electrode resistance of 1 M Ω (cell model). This gives a time constant of 10 - 30 μ s (corner frequencies of 5 - 15 kHz). With $C_m = 100$ nF and $T_e = 20$ μ s (8 kHz bandwidth), the gain can be calculated as:

$$\text{LO: } K = 1.25 \text{ mA / V}$$

$$\text{MO: } K = 2.5 \text{ mA / V}$$

The standard TEC current source has a calibration of 10 μ A / V. This means that the gain stages related to the GAIN control on the front panel must provide a gain between 125-250. In the TEC system the gain amplifier is composed of two stages: x10 (fix) and 1 - 100 (variable). The maximum gain of the variable gain stage can be set with an internal trim potentiometer.

If a command step of 150 mV is applied, the output of the first stage is 1.5V, while the second stage goes into saturation if the gain values calculated above are used. Therefore, the capacitive transients will have large nonlinear components.

A response with no saturation effects is obtainable only with command signals below 100 mV. With larger membrane capacities the saturation effects start even earlier, because a higher gain is required. In this situation, systems with higher output compliance and / or headstage with x2, x5 or x10 ranges must be used to improve clamp response. In this case the saturation effect of the gain amplifier is avoided (Polder and Houamed, 1994; Greeff and Polder, 1997; Polder et al., 1997).

The speed of response (with x1 headstage and 150 V output) from the point of view of control theory is:

$$T_r = 94 \mu\text{s}$$

$$T_s = 168 \mu\text{s}$$

Maximum speed of response

The speed of an ideal VC system is limited only by the maximum current delivered by the current source:

$$[dUm/dt]_{\text{max}} = U_{\text{max}} / (C_m * R_{\text{EL}})$$

$$[dUm/dt]_{\text{max}} = 150 \text{ V} / (0.1 \mu\text{F} * 1 \text{ M}\Omega) = 1500 \text{ V} / \text{s} = 1.5 \text{ mV} / \mu\text{s}$$

It would last 100 μs to reach 150 mV, provided that the clamp has an ideal characteristic.

Now the minimum bandwidth of a real clamp system necessary for "ideal" behavior can be calculated:

$$T_s = 8.4 * T_e = 100 \mu\text{s} \quad \text{gives } T_e = 12 \mu\text{s}; \quad \text{BW} = 1 / (2 * \pi * T_e) = 13 \text{ kHz}$$

with BW = bandwidth

If we assume that T_e is determined by 70 - 80% by the time constant of the current electrode (i.e. $T_{el} = 10 \mu\text{s}$ if $T_e = 12 \mu\text{s}$) it is clear that with electrode resistances in the range of 500 k Ω the total capacity related to the current injecting electrode can be maximum 20 pF. In this case the maximum cable length is 15 - 20 cm.

A cable of 0.5 - 1.5 m has a capacity in the range of 50 - 200 pF. With such a capacity and an electrode resistance of 1 M Ω , T_e is in the range of 50 - 200 μs and the speed of response would be in a range of 0.5 - 2 ms!

Conclusions:

1. For adequate VC experiments a clamp gain of 1 - 5 mA / V (i.e. 100 - 500 internal gain with a current source calibration of 10 $\mu\text{A} / \text{V}$) is necessary. Therefore, with pulse amplitudes of 100 - 200 mV the operational amplifiers in the gain stages will be saturated causing nonlinear components in the capacitive transients.
2. The maximum speed of response is determined by the cell capacity, the maximum available current and the command amplitude.
3. The real speed of response is determined by the time constant associated with the current injecting electrode. It is strongly dependent on the length of the cable that connects the headstage with the electrode holder.

Important: The speed of response and the linearity of the capacitive transients can be improved considerably if a current headstage with a steeper gain (x2 = 20 $\mu\text{A} / \text{V}$, x5 = 50 $\mu\text{A} / \text{V}$) is used especially in combination with a higher output voltage of $\pm 225 \text{ V}$ (TEC 225 System) and an improved series resistance compensation (Dietzel et al., 1992; Polder and Houamed, 1994; Greeff and Polder, 1997; Greeff and Kühn, 2000).

13. References

Recording Methods and Voltage Clamp Technique

- ❑ Dietzel, I. D., Bruns, D., Polder, H. R., & Lux, H. D. (1992). Voltage Clamp Recording. In *Practical Electrophysiological Methods*, eds. Kettenmann, H. & Grantyn, R., pp. 256-262. Wiley-Liss, New York.
- ❑ Greeff, N. G. & Polder, H. R. (1997). An optimized, high current oocyte clamp amplifier with ultralinear low-noise response. In *Göttingen Neurobiology Report 1997*, eds. Elsner, N. & Wässle, H., Thieme Verlag Stuttgart.
- ❑ Greeff, N. G., Conti, F., Gaggero, E., Planck, J., Polder, H. R., Terlau, H., & Weskamp, M., (2002). TEVC Recording from *Xenopus* Oocytes; Series Resistance and Space-clamp. *Biophys. J.*, **82**, 267a.
- ❑ Polder, H. R. & Houamed, K. (1994). A New, Ultra-High Voltage Oocyte Voltage/Current Clamp Amplifier. In *Göttingen Neurobiology Report 1994*, eds. Elsner, N & H. Breer, Thieme Verlag Stuttgart.
- ❑ Polder, H. R., Schliephacke, R., Stühmer, W., & Terlau, H. (1997). A new, switched mode double electrode clamp amplifier avoiding series resistance errors. in *Göttingen Neurobiology Report 1997*, eds. Elsner, N. & Wässle, H., Thieme Verlag Stuttgart.
- ❑ Polder, H. R., & Swandulla, D. (2001). The use of control theory for the design of voltage clamp systems: A simple and standardized procedure for evaluating system parameters. *J. Neurosci. Meth.* **109**, 97-109.
- ❑ Polder, H.R., M. Weskamp, K. Linz & R. Meyer (2004) Voltage-Clamp and Patch-Clamp Techniques, Chapter 3.4, 272-323 in: Dhein, Stefan; Mohr, Friedrich Wilhelm; Delmar, Mario (Eds.) *Practical Methods in Cardiovascular Research*, Springer, Berlin, Heidelberg and New York 2004.

Oocyte Techniques (Book Chapters)

- ❑ Stühmer, W. (1992) Electrophysiological Recording from *Xenopus* Oocytes, in Rudy B., & L.E. Iverson (eds.) *Ion Channels, Methods in Enzymology*, Vol. 207, Academic Press, San Diego.
- ❑ Stühmer, W., Terlau, H. and Heinemann, S. H. (1992) *Xenopus* Oocytes for Two-Electrode and Patch Clamp Recording, in Kettenmann, H. & Grantyn, R. (eds.) *Practical Electrophysiological Methods*, Wiley-Liss, New York.
- ❑ Stühmer, W. and A.B. Parekh (1995) Recording from *Xenopus* Oocytes, in Sakmann, B., and E. Neher (eds.) *Single Channel Recording*, Second Edition, Plenum Press, New York and London.
- ❑ Stühmer, W. (1998) Electrophysiologic Recordings from *Xenopus* Oocytes, in P. Michael Conn (ed.) *Ion Channels Part B, Meth. in Enzymology* Vol. 293, Academic Press, San Diego.
- ❑ Wagner, C. A., Friedrich, B., Setiawan, I., Lang, F., & Broer, S. (2000). The use of *Xenopus laevis* oocytes for the functional characterization of heterologously expressed membrane proteins. *Cell Physiol Biochem.* **10**, 1-12.

Na⁺ Channel Gating Currents

- ❑ Frank J.P. Kühn and Nikolaus G. Greeff (1999) Movement of Voltage Sensor S4 in Domain 4 Is Tightly Coupled to Sodium Channel Fast Inactivation and Gating Charge Immobilization, *Journal of General Physiology* Volume 114, 1–18, August 1999
- ❑ Greeff, N.G. and F.J.P. Kühn (2000) Variable Ratio of Permeability to Gating Charge of rBIIA Sodium Channels and Sodium Influx in *Xenopus* Oocytes, *Biophys. Journal*, Vol. 79, 2434-59
- ❑ Greeff, N.G. and H. R. Polder (1998) Optimization of a Two-Electrode Voltage Clamp for Recording of Sodium Gating Currents from *Xenopus* Oocytes, *Biophysical Meeting Kansas City*
- ❑ Kühn, F.J.P. and N.G. Greeff, (2002). Mutation D384N Alters Recovery of the Immobilized Gating Charge in Rat Brain IIA Sodium Channels. *J. Membr. Biol.*, 185, 145-155.

Na⁺ Channels

- ❑ Hilber, K., Sandtner, W., Kudlacek, O., Glaaser, I. W., Weisz, E., Kyle, J. W., French, R. J., Fozzard, H. A., Dudley, S. C., & Todt, H. (2001) The Selectivity Filter of the Voltage-gated Sodium Channel Is Involved in Channel Activation. *J.Biol.Chem.* **276**, 27831–27839.
- ❑ Hilber, K., Sandtner, W., Kudlacek, O., Schreiner, B. Glaaser, I. W., Schütz, W. Fozzard, H. A., Dudley, S. C., & Todt, H. (2002) Interaction between Fast and Ultra-slow Inactivation in the Voltage-gated Sodium Channel. *J.Biol.Chem.* **277**, 37105–37115.
- ❑ Szendroedi, J., Sandtner, W., Zarrabi, T., Zebedin, E., Hilber, K., Dudley, S. C., Fozzard, H. A., & Todt, H. (2007). Speeding the Recovery from Ultra-Slow Inactivation of Voltage-Gated Na⁺ Channels by Metal Ion Binding to the Selectivity Filter: A Foot-on-the-Door? *Biophys.J.*
- ❑ Volk, T., Konstas, A. A., Bassalay, P., Ehmke, H., & Korbmacher, C. (2004). Extracellular Na⁽⁺⁾ removal attenuates rundown of the epithelial Na⁽⁺⁾-channel (ENaC) by reducing the rate of channel retrieval. *Pflugers Arch.* **447**, 884-894.

Ca²⁺ Channels

- ❑ Hoda, J. C., Zaghetto, F., Koschak, A., & Striessnig, J. (2005). Congenital Stationary Night Blindness Type 2 Mutations S229P, G369D, L1068P, and W1440X Alter Channel Gating or Functional Expression of Cav1.4 L-type Ca²⁺ Channels. *Journal of Neuroscience* **25**, 252-259.

K⁺ Channel Gating Currents

- ❑ McCormack, K., W.J. Joiner and St.H. Heinemann (1994) A Characterization of the Activating Structural Rearrangements in Voltage-Dependent *Shaker* K⁺ Channels, *Neuron* Vol.12, 301-315

Expression of Plant Channels

- ❑ Becker, D., I. Dreyer, St. Hoth, J.D. Reid, H. Busch, M. Lehnen, K. Palme and R. Hedrich (1996) Changes in voltage activation, Cs⁺ sensitivity, and ion permeability in H5 mutants of the plant K⁺ channel KAT1, *Proc. Natl. Acad. Sci. USA*, Vol. 93, pp. 8123-8128.
- ❑ Michard, E., Lacombe, B., Poree, F., Mueller-Roeber, B., Sentenac, H., Thibaud, J. B., & Dreyer, I. (2005). A unique voltage sensor sensitizes the potassium channel AKT2 to phosphoregulation. *J Gen.Physiol.* **126**, 605-617.
- ❑ Philippar, K., Buchsenschutz, K., Abshagen, M., Fuchs, I., Geiger, D., Lacombe, B., & Hedrich, R. (2003). The K⁺ channel KZM1 mediates potassium uptake into the phloem and guard cells of the C4 grass *Zea mays*. *J Biol.Chem.* **278**, 16973-16981.
- ❑ Tsunoda, S. P., Ewers, D., Gazzarrini, S., Moroni, A., Gradmann, D., & Hegemann, P. (2006). H⁺ pumping rhodopsin from the marine alga *Acetabularia*. *Biophys.J.*

K⁺ Channels

- ❑ Baltaev, R., Strutz-Seeböhm, N., Korniyuchuk, G., Myssina, S., Lang, F., & Seeböhm, G. (2005). Regulation of cardiac shal-related potassium channel Kv 4.3 by serum- and glucocorticoid-inducible kinase isoforms in *Xenopus* oocytes. *Pflugers Arch.* **450**, 26-33.
- ❑ Bayrhuber, M., Vijayan, V., Ferber, M., Graf, R., Korukottu, J., Imperial, J., Garrett, J. E., Olivera, B. M., Terlau, H., Zweckstetter, M., & Becker, S. (2005). Conkunitzin-S1 is the first member of a new Kunitz-type neurotoxin family - structural and functional characterization. *Journal of Biological Chemistry* C500064200.
- ❑ Collins, A., Wang, H., & Larson, M. K. (2005). Differential Sensitivity of Kir2 Inward-Rectifier Potassium Channels to a Mitochondrial Uncoupler: Identification of a Regulatory Site. *Molecular Pharmacology* **67**, 1214-1220.
- ❑ Decher, N., Pirard, B., Bundis, F., Peukert, S., Baringhaus, K. H., Busch, A. E., Steinmeyer, K., & Sanguinetti, M. C. (2004). Molecular Basis for Kv1.5 Channel Block: CONSERVATION OF DRUG BINDING SITES AMONG VOLTAGE-GATED K⁺ CHANNELS. *Journal of Biological Chemistry* **279**, 394-400.
- ❑ Decher, N., Renigunta, V., Zuzarte, M., Soom, M., Heinemann, S. H., Timothy, K. W., Keating, M. T., Daut, J., Sanguinetti, M. C., & Splawski, I. (2007). Impaired interaction between the slide helix and the C-terminus of Kir2.1: a novel mechanism of Andersen syndrome. *Cardiovasc.Res.* **75**, 748-757.
- ❑ Dellinger, M., Wischmeyer, E., Dityatev, A., Sytnyk, V., Veh, R. W., Karschin, A., & Schachner, M. (2002). The neural cell adhesion molecule regulates cell-surface delivery of G-protein-activated inwardly rectifying potassium channels via lipid rafts. *J.Neurosci.* **22**, 7154-7164.
- ❑ Derst, C., Hirsch, J. R. Preisig-Müller, R., Wischmeyer, E., Karschin, A., Döring, F., Thomzig, A., Veh, R. W., Schlatter, E., Kummer, W. and Daut, J. (2001). Cellular localization of the potassium channel Kir7.1 in guinea pig and human kidney. *Kidney International* **59**, 2197-2205.
- ❑ Derst, C., Karschin, C., Wischmeyer, E., Hirsch, J. R., Preisig-Müller, R., Rajan, S., Engel, H., Grzeschik, K. H., Daut, J. and Karschin, A. (2001). Genetic and functional linkage of Kir5.1 and Kir2.1 channel subunits. *FEBS Letters* **491**, 305-311.

- ❑ Ferber, M., Sporning, A., Jeserich, G., DeLaCruz, R., Watkins, M., Olivera, B. M., & Terlau, H. (2003). A novel conus peptide ligand for K⁺ channels. *J Biol.Chem.* **278**, 2177-2183.
- ❑ Fleischmann, B. K., Duan, Y., Fan, Y., Schoneberg, T., Ehlich, A., Lenka, N., Viatchenko-Karpinski, S., Pott, L., Hescheler, J., & Fakler, B. (2004). Differential subunit composition of the G protein-activated inward-rectifier potassium channel during cardiac development. *J Clin.Invest.* **114**, 994-1001.
- ❑ Gomez-Varela, D., de la, P. P., Garcia, J., Giraldez, T., & Barros, F. (2002). Influence of amino-terminal structures on kinetic transitions between several closed and open states in human erg K⁺ channels. *J Membr.Biol.* **187**, 117-133.
- ❑ Gomez-Varela, D., Barros, F., Vilorio, C. G., Giraldez, T., Manso, D. G., Dupuy, S. G., Miranda, P., & de la, P. P. (2003). Relevance of the proximal domain in the amino-terminus of HERG channels for regulation by a phospholipase C-coupled hormone receptor. *FEBS Lett.* **535**, 125-130.
- ❑ Karschin, C., Wischmeyer, E., Preisig-Müller, R., Rajan, S., Derst, C., Grzeschik, K. H., Daut, J. and Karschin, A. (2001). Expression Pattern in Brain of TASK-1, TASK-3, and a Tandem Pore Domain K1 Channel Subunit, TASK-5, Associated with the Central Auditory Nervous System. *Mol.Cell.Neurosci.* **18**, 632–648.
- ❑ Kerschensteiner, D., Monje, F., & Stocker, M. (2003). Structural determinants of the regulation of the voltage-gated potassium channel Kv2.1 by the modulatory alpha-subunit Kv9.3. *J Biol.Chem.* **278**, 18154-18161.
- ❑ Lange, A., Giller, K., Hornig, S., Martin-Eauclaire, M. F., Pongs, O., Becker, S., & Baldus, M. (2006). Toxin-induced conformational changes in a potassium channel revealed by solid-state NMR. *Nature.* **440**, 959-962.
- ❑ Lerche, C., Scherer, C. R., Seeböhm, G., Derst, C., Weii, A. D., Busch, A. E. and K. Steinmeyer (2000) Molecular Cloning and Functional Expression of KCNQ5, a Potassium Channel Subunit That May Contribute to Neuronal M-current Diversity, *J. Biol. Chem* **275** (29):22395–22400
- ❑ Lerche, C., Seeböhm, G., Wagner, C. I., Scherer, C. R., Dehmelt, L., Abitbol, I., Gerlach, U., Brendel, J., Attali, B. and A. E. Busch. (2000) Molecular impact of MinK on the enantiospecific block of I(Ks) by chromanols, *Br. J. Pharmacol.* **131**(8):1503-6.
- ❑ Lerche, C., Bruhova, I., Lerche, H., Steinmeyer, K., Wei, A. D., Strutz-Seeböhm, N., Lang, F., Busch, A. E., Zhorov, B. S., & Seeböhm, G. (2007). Chromanol 293B binding in KCNQ1 (Kv7.1) channels involves electrostatic interactions with a potassium ion in the selectivity filter. *Mol Pharmacol.* **71**, 1503-1511.
- ❑ Maljevic, S., Lerche, C., Seeböhm, G., Alekov, A. K., Busch, A. E., & Lerche, H. (2003). C-terminal interaction of KCNQ2 and KCNQ3 K⁺ channels. *J Physiol.* **548.2**, 353-360.
- ❑ Marble, D. D., Hegle, A. P., Snyder, E. D., Dimitratos, S., Bryant, P. J., & Wilson, G. F. (2005). Camguk/CASK enhances Ether-a-go-go potassium current by a phosphorylation-dependent mechanism. *J Neurosci.* **25**, 4898-4907.
- ❑ Hou, P., Di, A. Huang, P., Hansen, C. B. and Nelson, D. J. (2000). Impermeability of the GIRK2 *weaver* channel to divalent cations. *Am.J.Physiol.* **278**. C1038–C1046.
- ❑ Putzke, C., Wemhoner, K., Sachse, F. B., Rinne, S., Schlichthorl, G., Li, X. T., Jae, L., Eckhardt, I., Wischmeyer, E., Wulf, H., Preisig-Muller, R., Daut, J., & Decher, N. (2007). The acid-sensitive potassium channel TASK-1 in rat cardiac muscle. *Cardiovasc.Res.* **75**, 59-68.

- ❑ Reuveny, E. (2002). Trapping the sensor. *Neuron* **35**, 814-815.
- ❑ Sarac, R., Hou, P., Hurley, K. M., Hriciste, D., Cohen, N. A., & Nelson, D. J. (2005). Mutation of critical GIRK subunit residues disrupts N- and C-termini association and channel function. *J Neurosci* **25**, 1836-1846.
- ❑ Schenzer, A., Friedrich, T., Pusch, M., Saftig, P., Jentsch, T. J., Grotzinger, J., & Schwake, M. (2005). Molecular determinants of KCNQ (Kv7) K⁺ channel sensitivity to the anticonvulsant retigabine. *J Neurosci.* **25**, 5051-5060.
- ❑ Schonherr, R., Mannuzzu, L. M., Isacoff, E. Y., & Heinemann, S. H. (2002). Conformational switch between slow and fast gating modes: allosteric regulation of voltage sensor mobility in the EAG K⁺ channel. *Neuron* **35**, 935-949.
- ❑ Schwake, M., Athanasiadu, D., Beimgraben, C., Blanz, J., Beck, C., Jentsch, T. J., Saftig, P., & Friedrich, T. (2006). Structural determinants of M-type KCNQ (Kv7) K⁺ channel assembly. *J Neurosci.* **26**, 3757-3766.
- ❑ Seeböhm, G., Lerche, C., Busch, A. E. and A. Bachmann (2001) Dependence of *I*_{Ks} biophysical properties on the expression system, *Pflügers Arch.* 2001
- ❑ Seeböhm, G., Scherer, C. R., Busch, A. E. and C. Lerche (2001) Identification of Specific Pore Residues Mediating KCNQ1 Inactivation, A Novel Mechanism For Long Qt Syndrome, *J. Biol. Chem.* 276 (17)13600–13605
- ❑ Seeböhm, G., Lerche, C., Pusch, M., Steinmeyer, K., Brüggemann, A. and A. E. Busch (2001) A kinetic study on the stereospecific inhibition of KCNQ1 and IKs by the chromanol 293B, *Br. J. Pharmacol.* 134:1647-1654
- ❑ Seeböhm, G., Westenskow, P., Lang, F., & Sanguinetti, M. C. (2005). Mutation of colocalized residues of the pore helix and transmembrane segments S5 and S6 disrupt deactivation and modify inactivation of KCNQ1 K⁺ channels. *J. Physiol.* **563.2**, 359-368.
- ❑ Seeböhm, G., Strutz-Seeböhm, N., Ureche, O. N., Baltaev, R., Lampert, A., Kornichuk, G., Kamiya, K., Wuttke, T. V., Lerche, H., Sanguinetti, M. C., & Lang, F. (2006). Differential Roles of S6 Domain Hinges in the Gating of KCNQ Potassium Channels. *Biophys.J.* **90**, 2235-2244.
- ❑ Strutz-Seeböhm, N., Seeböhm, G., Fedorenko, O., Baltaev, R., Engel, J., Knirsch, M., & Lang, F. (2006). Functional Coassembly of KCNQ4 with KCNE-Beta- Subunits in *Xenopus Oocytes*. *Cell Physiol Biochem.* **18**, 57-66.
- ❑ Ullrich, S., Berchtold, S., Ranta, F., Seeböhm, G., Henke, G., Lupescu, A., Mack, A. F., Chao, C. M., Su, J., Nitschke, R., Alexander, D., Friedrich, B., Wulff, P., Kuhl, D., & Lang, F. (2005). Serum- and Glucocorticoid-Inducible Kinase 1 (SGK1) Mediates Glucocorticoid-Induced Inhibition of Insulin Secretion. *Diabetes* **54**, 1090-1099.
- ❑ Wuttke, T. V., Seeböhm, G., Bail, S., Maljevic, S., & Lerche, H. (2005). The New Anticonvulsant Retigabine Favors Voltage-Dependent Opening of the Kv7.2 (KCNQ2) Channel by Binding to Its Activation Gate. *Molecular Pharmacology* **67**, 1009-1017.

Chloride and epithelial Na⁺ Channels

- ❑ Estévez, R., Schroeder, B. C., Accardi, A., Jentsch, T. J., & Pusch, M. (2003). Conservation of Chloride Channel Structure Revealed by an Inhibitor Binding Site in ClC-1. *Neuron* **38**, 47–59.

- ❑ Estevez, R., Pusch, M., Ferrer-Costa, C., Orozco, M., & Jentsch, T. J. (2004). Functional and structural conservation of CBS domains from CLC chloride channels. *J Physiol* **557**, 363-378.
- ❑ Fong, P., Rehfeldt, A. and Jentsch, T. J. (1998). Determinants of slow gating in ClC-0, the voltage gated chloride channel of *Torpedo marmorata*. *Am.J.Physiol.* **274** , C966–C973.
- ❑ Liantonio, A., Picollo, A., Babini, E., Carbonara, G., Fracchiolla, G., Loiodice, F., Tortorella, V., Pusch, M., & Conte, C. D. (2005). Activation and inhibition of kidney CLC-K chloride channels by fenamates. *Molecular Pharmacology* **96**, 165-173.
- ❑ Nagel, G., Szellas, T., Riordan, J.R., Friedrich, T. and K. Hartung (2001) Non specific activation of the epithelial sodium channel by the CFTR chloride channel, *EMBO reports*, Vol 21, 249-254.
- ❑ Nagel, G., Barbry, P., Chabot, H., Brochiero, E., Hartung, K., & Grygorczyk, R. (2005). CFTR fails to inhibit the epithelial sodium channel ENaC, when expressed in *Xenopus laevis* oocytes. *J.Physiol.* **564**, 671-682.
- ❑ Sacchi, O., Rossi, M. L., Canella, R., & Fesce, R. (2003). Voltage- and activity-dependent chloride conductance controls the resting status of the intact rat sympathetic neuron. *J Neurophysiol.* **90**, 712-722.
- ❑ Schnizler, K., Saeger, B., Pfeffer, C., Gerbaulet, A., Ebbinghaus-Kintscher, U., Methfessel, C., Franken, E. M., Raming, K., Wetzel, C. H., Saras, A., Pusch, H., Hatt, H., & Gisselmann, G. (2005). A Novel Chloride Channel in *Drosophila melanogaster* Is Inhibited by Protons. *Journal of Biological Chemistry* **280**, 16254-16262.

TRP Channels

- ❑ Garcia-Sanz, N., Valente, P., Gomis, A., Fernandez-Carvajal, A., Fernandez-Ballester, G., Viana, F., Belmonte, C., & Ferrer-Montiel, A. (2007). A role of the transient receptor potential domain of vanilloid receptor I in channel gating. *J Neurosci.* **27**, 11641-11650.
- ❑ Kottgen, M., Benzing, T., Simmen, T., Tauber, R., Buchholz, B., Feliciangeli, S., Huber, T. B., Schermer, B., Kramer-Zucker, A., Hopker, K., Simmen, K. C., Tschucke, C. C., Sandford, R., Kim, E., Thomas, G., & Walz, G. (2005). Trafficking of TRPP2 by PACS proteins represents a novel mechanism of ion channel regulation. *The EMBO Journal* **24**, 705-716.

Incorporation of Proteins in the Oocyte Membrane

- ❑ Caprini, M., Fava, M., Valente, P., Fernandez-Ballester, G., Rapisarda, C., Ferroni, S., & Ferrer-Montiel, A. (2005). Molecular Compatibility of the Channel Gate and the N Terminus of S5 Segment for Voltage-gated Channel Activity. *Journal of Biological Chemistry* **280**, 18253-18264.
- ❑ Clyne, J. D., Wang, L. F., & Hume, R. I. (2002). Mutational analysis of the conserved cysteines of the rat P2X2 purinoceptor. *J Neurosci.* **22**, 3873-3880.
- ❑ Everts, I., Petroski, R., Kizelsztejn, P., Teichberg, V. I., Heinemann, S. F. & Hollmann, M. (1999). Lectin-Induced Inhibition of Desensitization of the Kainate Receptor GluR6 Depends on the Activation State and Can Be Mediated by a Single Native or Ectopic N-Linked Carbohydrate Side Chain. *J. Neurosci.* **19**, 916–927.
- ❑ Gu, Q. B., Zhao, J. X., Fei, J., & Schwarz, W. (2004). Modulation of Na(+),K(+) pumping and neurotransmitter uptake by beta-amyloid. *Neuroscience* **126**, 61-67.

- ❑ Hausmann, R., Rettinger, J., Gerevich, Z., Meis, S., Kassack, M. U., Illes, P., Lambrecht, G., & Schmalzing, G. (2006). The suramin analog 4,4',4'',4'''-(carbonylbis(imino-5,1,3-benzenetriylbis (carbonylimino)))tetra-kis-benzenesulfonic acid (NF110) potently blocks P2X3 receptors: subtype selectivity is determined by location of sulfonic acid groups. *Molecular Pharmacology* **69**, 2058-2067.
- ❑ Inglis, F. M., Crockett, R., Korada, S., Abraham, W. C., Hollmann, M., & Kalb, R. G. (2002). The AMPA receptor subunit GluR1 regulates dendritic architecture of motor neurons. *J Neurosci.* **22**, 8042-8051.
- ❑ Jenke, M., Sanchez, A., Monje, F., Stuhmer, W., Weseloh, R. M., & Pardo, L. A. (2003). C-terminal domains implicated in the functional surface expression of potassium channels. *EMBO J* **22**, 395-403.
- ❑ Krause, S. & Schwarz, W. (2005). Identification and Selective Inhibition of the Channel Mode of the Neuronal GABA Transporter 1. *Molecular Pharmacology* **68**, 1728-1735.
- ❑ Lu, W., Zheng, B. J., Xu, K., Schwarz, W., Du, L., Wong, C. K. L., Chen, J., Duan, S., Deubel, V., & Sun, B. (2006). Severe acute respiratory syndrome-associated coronavirus 3a protein forms an ion channel and modulates virus release. *Proceedings of the National Academy of Sciences* **103**, 12540-12545.
- ❑ Marquez-Klaka, B., Rettinger, J., Bhargava, Y., Eisele, T., & Nicke, A. (2007). Identification of an intersubunit cross-link between substituted cysteine residues located in the putative ATP binding site of the P2X1 receptor. *J Neurosci.* **27**, 1456-1466.
- ❑ Morales, A., J.Aleu, I.Ivorra, J.A. Ferragut, J.M.Gonzales-Ros and R.Miledi (1995) Incorporation of reconstituted acetylcholine receptors from *Torpedo* in the *Xenopus* oocyte membrane, Proc. Natl.Acad.Sci.USA Vol. 92, pp. 8468-8472
- ❑ Nawrath, H., Wegener, J. W., Rupp, J., Habermeier, A. and Closs, E. I. (2000). Voltage dependence of L-arginine transport by hCAT-2A and hCAT-2B expressed in oocytes from *Xenopus laevis*. *Am.J.Physiol.* **279**, C1336–C1344.
- ❑ Pertovaara, A., Ostergard, M., Anko, M. L., Lehti-Koivunen, S., Brandt, A., Hong, W., Korpi, E. R., & Panula, P. (2005). RFamide-related peptides signal through the neuropeptide FF receptor and regulate pain-related responses in the rat. *Neuroscience* **134**, 1023-1032.
- ❑ Rettinger, J. & Schmalzing, G. (2003). Activation and desensitization of the recombinant P2X1 receptor at nanomolar ATP concentrations. *J Gen.Physiol* **121**, 451-461.
- ❑ Schmidt, C., Werner, M., & Hollmann, M. (2006). Revisiting the postulated "unitary glutamate receptor": electrophysiological and pharmacological analysis in two heterologous expression systems fails to detect evidence for its existence. *Molecular Pharmacology* **69**, 119-129.
- ❑ Schroder-Lang, S., Schwarzel, M., Seifert, R., Strunker, T., Kateriya, S., Looser, J., Watanabe, M., Kaupp, U. B., Hegemann, P., & Nagel, G. (2007). Fast manipulation of cellular cAMP level by light in vivo. *Nat Meth* **4**, 39-42.
- ❑ Strutz-Seebohm, N., Werner, M., Madsen, D. M., Seebohm, G., Zheng, Y., Walker, C. S., Maricq, A. V., & Hollmann, M. (2003). Functional analysis of *Caenorhabditis elegans* glutamate receptor subunits by domain transplantation. *J Biol.Chem.* **278**, 44691-44701.
- ❑ Strutz-Seebohm, N., Seebohm, G., Shumilina, E., Mack, A. F., Wagner, H. J., Lampert, A., Grahmmer, F., Henke, G., Just, L., Skutella, T., Hollmann, M., & Lang, F. (2005). Glucocorticoid adrenal steroids and glucocorticoid-inducible kinase isoforms in the regulation of GluR6 expression. *J Physiol* **565**, 391-401.

- ❑ Strutz-Seebohm, N., Seebohm, G., Mack, A. F., Wagner, H. J., Just, L., Skutella, T., Lang, U. E., Henke, G., Striegel, M., Hollmann, M., Rouach, N., Nicoll, R. A., McCormick, J. A., Wang, J., Pearce, D., & Lang, F. (2005). Regulation of GluR1 abundance in murine hippocampal neurones by serum- and glucocorticoid-inducible kinase 3. *J Physiol* **565**, 381-390.
- ❑ Strutz-Seebohm, N., Seebohm, G., Korniychuk, G., Baltaev, R., Ureche, O., Striegel, M., & Lang, F. (2006). Additive regulation of GluR1 by stargazin and serum- and glucocorticoid-inducible kinase isoform SGK3. *Pflugers Arch.* **452**, 276-282.
- ❑ Sinkkonen, S. T., Mansikkamaki, S., Moykkynen, T., Luddens, H., Uusi-Oukari, M., & Korpi, E. R. (2003). Receptor subtype-dependent positive and negative modulation of GABA(A) receptor function by niflumic acid, a nonsteroidal anti-inflammatory drug. *Mol Pharmacol.* **64**, 753-763.
- ❑ Wetzel C. H., Oles, M., Wellerdieck, C., Kuczkowiak, M., Gisselmann, G. and H. Hatt (1999) Specificity and Sensitivity of a Human Olfactory Receptor Functionally Expressed in Human Embryonic Kidney 293 Cells and *Xenopus Laevis* Oocytes, *J. Neurosci*, 19(17):7426–7433.

Transporter expressed in the Oocyte Membrane

- ❑ Boll, M., Foltz, M., Rubio-Aliaga, I., Kottra, G., & Daniel, H. (2002). Functional characterization of two novel mammalian electrogenic proton-dependent amino acid cotransporters. *J Biol.Chem.* **277**, 22966-22973.
- ❑ Carpaneto, A., Geiger, D., Bamberg, E., Sauer, N., Fromm, J., & Hedrich, R. (2005). Phloem-localized, proton-coupled sucrose carrier ZmSUT1 mediates sucrose efflux under the control of the sucrose gradient and the proton motive force. *Journal of Biological Chemistry* **280**, 21437-21443.
- ❑ Cui, W. W., Low, S. E., Hirata, H., Saint-Amant, L., Geisler, R., Hume, R. I., & Kuwada, J. Y. (2005). The zebrafish shocked gene encodes a glycine transporter and is essential for the function of early neural circuits in the CNS. *J Neurosci.* **25**, 6610-6620.
- ❑ Dunlop, J., McIlvain, H. B., Carrick, T. A., Jow, B., Lu, Q., Kowal, D., Lin, S., Greenfield, A., Grosanu, C., Fan, K., Petroski, R., Williams, J., Foster, A., & Butera, J. (2005). Characterization of novel aryl-ether, biaryl, and fluorene aspartic acid and diaminopropionic acid analogs as potent inhibitors of the high-affinity glutamate transporter EAAT2. *Molecular Pharmacology* **68**, 974-982.
- ❑ Foltz, M., Mertl, M., Dietz, V., Boll, M., Kottra, G., & Daniel, H. (2005). Kinetics of bidirectional H⁺ and substrate transport by the proton-dependent amino acid symporter PAT1. *Biochem.J.* **386**, 607-616.
- ❑ Gorbunov, D., Gorboulev, V., Shatskaya, N., Mueller, T., Bamberg, E., Friedrich, T., & Koepsell, H. (2007). High-affinity Cation Binding to Transporter OCT1 Induces Movement of Helix 11 and Blocks Transport after Mutations in a Modelled Interaction Domain between Two Helices. *Mol Pharmacol.*
- ❑ Kottra, G. and H. Daniel (2001) Bidirectional electrogenic transport of peptides by the proton-coupled carrier PEPT1 in *Xenopus laevis* oocytes: its asymmetry and symmetry, *J. Physiol.* 536.2:495-503.
- ❑ Picollo, A. & Pusch, M. (2005). Chloride/proton antiporter activity of mammalian CLC proteins ClC-4 and ClC-5. *Nature* **436**, 420-423.

- ❑ Schmitt, B. M. & Koepsell, H. (2005). Alkali Cation Binding and Permeation in the Rat Organic Cation Transporter rOCT2. *J Biol.Chem.* **280**, 24481-24490.
- ❑ Theis, S., Hartrodt, B., Kottra, G., Neubert, K., & Daniel, H. (2002). Defining minimal structural features in substrates of the H(+)/peptide cotransporter PEPT2 using novel amino acid and dipeptide derivatives. *Mol.Pharmacol.* **61**, 214-221.
- ❑ Theis, S., Knutter, I., Hartrodt, B., Brandsch, M., Kottra, G., Neubert, K., & Daniel, H. (2002). Synthesis and characterization of high affinity inhibitors of the H+/peptide transporter PEPT2. *J Biol.Chem.* **277**, 7287-7292.
- ❑ Verri, T., Kottra, G., Romano, A., Tiso, N., Peric, M., Maffia, M., Boll, M., Argenton, F., Daniel, H., & Storelli, C. (2003). Molecular and functional characterisation of the zebrafish (*Danio rerio*) PEPT1-type peptide transporter. *FEBS Lett.* **549**, 115-122.

Fast Perfusion Technique (ScreeningTool)

- ❑ Baburin, I., Beyl, S., & Hering, S. (2006). Automated fast perfusion of *Xenopus* oocytes for drug screening. *Pflugers Arch.* **453**, 117-123.
- ❑ Khom, S., Baburin, I., Timin, E. N., Hohaus, A., Sieghart, W., & Hering, S. (2006). Pharmacological properties of GABAA receptors containing gamma1 subunits. *Molecular Pharmacology* **69**, 640-649.
- ❑ Khom, S., Baburin, I., Timin, E., Hohaus, A., Trauner, G., Kopp, B., & Hering, S. (2007). Valerenic acid potentiates and inhibits GABA(A) receptors: Molecular mechanism and subunit specificity. *Neuropharmacology.* **53**, 178-187.
- ❑ Stork, D., Timin, E. N., Berjukow, S., Huber, C., Hohaus, A., Auer, M., & Hering, S. (2007). State dependent dissociation of HERG channel inhibitors. *Br.J Pharmacol.* **151**, 1368-1376.

Automated Recordings Using the CellWorks (EggWorks) Software

- ❑ Anson, L.C., et. al. (1998) Identification of Amino Acid Residues of the NR2A Subunit That Control Glutamate Potency in Recombinant NR1/NR2A NMDA Receptors, *J. Neurosci.* **18** (2): 581-598
- ❑ Bo, X., et. al. (1995) A P2X purino receptor cDNA conferring a novel pharmacological profile, *FEBS Letters* **375**: 129-133
- ❑ Burnashev, N. et. al. (1992) Control by asparagine residues of calcium permeability and magnesium blockade in the NMDA receptor. *Science* **257**, 1415-1419
- ❑ Chen, P. E., Johnston, A. R., Mok, M. H., Schoepfer, R., & Wyllie, D. J. (2004). Influence of a threonine residue in the S2 ligand binding domain in determining agonist potency and deactivation rate of recombinant NR1a/NR2D NMDA receptors. *J Physiol* **558**, 45-58.
- ❑ Hausmann, R., Rettinger, J., Gerevich, Z., Meis, S., Kassack, M. U., Illes, P., Lambrecht, G., & Schmalzing, G. (2006). The suramin analog 4,4',4'',4'''-(carbonylbis(imino-5,1,3-benzenetriylbis (carbonylimino)))tetra-kis-benzenesulfonic acid (NF110) potently blocks P2X3 receptors: subtype selectivity is determined by location of sulfonic acid groups. *Molecular Pharmacology* **69**, 2058-2067.
- ❑ Kuner, Th. and R. Schoepfer (1996) Multiple structural elements determine subunit-specificity of Mg²⁺ block in NMDA receptor channels. *Journal of Neuroscience*, **16**, 3549-3558

- ❑ Kuner, Th., et. al. (1996) Structure of the NMDA Receptor Channel M2 Segment Inferred from the Accessibility of Substituted Cysteins, *Neuron*, Vol 17 343-352
- ❑ Monyer, H., et. al. (1992) Heteromeric NMDA receptors: molecular and functional distinction of subtypes. *Science* 256, 1217-1221
- ❑ Rettinger, J. & Schmalzing, G. (2003). Activation and desensitization of the recombinant P2X1 receptor at nanomolar ATP concentrations. *J Gen.Physiol* **121**, 451-461.
- ❑ Rettinger, J. & Schmalzing, G. (2004). Desensitization masks nanomolar potency of ATP for the P2X1 receptor. *J Biol.Chem.* **279**, 6426-6433.
- ❑ Schoepfer, R., A. Föll and H.R. Polder (1996) EggWorks: A New Control Software for the Entire Experimental Setup, in: Elsner, N. and H.U. Schnitzler, Göttingen Neurobiology Report 1996, Thieme Verlag Stuttgart
- ❑ Schoepfer, R., G. Buchholz, J. Planck and H.R. Polder (2000) CellWorks: A Control Software for the Entire Experimental Setup, in: Jamal, R. and H. Jaschinski (eds) Virtuelle Instrumente in der Praxis, Hüthig Verlag Heidelberg.
- ❑ Schroder-Lang, S., Schwarzel, M., Seifert, R., Strunker, T., Kateriya, S., Looser, J., Watanabe, M., Kaupp, U. B., Hegemann, P., & Nagel, G. (2007). Fast manipulation of cellular cAMP level by light in vivo. *Nat Meth* **4**, 39-42.
- ❑ Sinkkonen, S. T., Mansikkamaki, S., Moykkynen, T., Luddens, H., Uusi-Oukari, M., & Korpi, E. R. (2003). Receptor subtype-dependent positive and negative modulation of GABA(A) receptor function by niflumic acid, a nonsteroidal anti-inflammatory drug. *Mol Pharmacol.* **64**, 753-763.

Recordings from Muscle Cells / Giant Fibers

- ❑ Bhattacharya, A., Gu, G. G., & Singh, S. (1999). Modulation of dihydropyridine-sensitive calcium channels in Drosophila by a cAMP-mediated pathway. *J Neurobiol.* **39**, 491-500.
- ❑ Bhattacharya, A., Lakhman, S. S., & Singh, S. (2004). Modulation of L-type calcium channels in Drosophila via a pituitary adenylyl cyclase-activating polypeptide (PACAP)-mediated pathway. *J Biol.Chem.* **279**, 37291-37297.
- ❑ Singh, A. & Singh, S. (1999). Unmasking of a novel potassium current in Drosophila by a mutation and drugs. *J Neurosci.* **19**, 6838-6843.
- ❑ Walther, Ch. et. al. (1998) Resting Membrane Properties of Locust Muscle and Their Modulation; I. Action of Neuropeptides YGGFMRFamide and Proctolin, *J.Neurophysiol.* 80:771-784
- ❑ Walther, Ch. and K.E. Zittlau (1998) Resting Membrane Properties of Locust Muscle and Their Modulation; II. Action of the Biogenic Amine Octopamine, *J.Neurophysiol.* 80:785-797
- ❑ Zordan, M. A., Massironi, M., Ducato, M. G., Te, K. G., Costa, R., Reggiani, C., Chagneau, C., Martin, J. R., & Megighian, A. (2005). Drosophila CAKI/CMG protein, a homolog of human CASK, is essential for regulation of neurotransmitter vesicle release. *Journal of Neurophysiology* **94**, 1074-1083.

Capacitance measurements

- ❑ Cohen, R., Schmitt, B. M., & Atlas, D. (2005). Molecular identification and reconstitution of depolarization-induced exocytosis monitored by membrane capacitance. *Biophys.J.* **89**, 4364-4373.
- ❑ Schmitt, B. M. and H. Koepsell (2002) An Improved Method For Real-Time Monitoring of Membrane Capacitance in *Xenopus laevis* Oocytes, *Biophys. J.* 82:1345–1357.

Proton Channels

- ❑ Nagel, G., Ollig, D., Fuhrmann, M., Kateriya, S., Musti, A. M., Bamberg, E., & Hegemann, P. (2002). Channelrhodopsin-1: a light-gated proton channel in green algae. *Science* **296**, 2395-2398.
- ❑ Nagel, G., Szellas, T., Huhn, W., Kateriya, S., Adeishvili, N., Berthold, P., Ollig, D., Hegemann, P., & Bamberg, E. (2003). Channelrhodopsin-2, a directly light-gated cation-selective membrane channel. *Proc.Natl.Acad.Sci.U.S.A.* **100**, 13940-13945.

14. TURBO TEC-03X Specifications – Technical Data

- All following current signal related parameters are for the TEC-03X amplifier with standard ± 150 V current headstage
- Parameters for the other systems or systems with selectable current ranges can be calculated from these parameters

MODES OF OPERATION

CC: Current Clamp mode
 VC: Voltage Clamp mode
 OFF: Current- and Voltage Clamp disabled
 EXTERN: External control mode; the mode of operation can be set by a TTL pulse applied to the MODE SELECT BNC. If CellWorks is used, some functions can be controlled from CellWorks (TEC-03X-CW)
 MODE selection: toggle switch, LED indicators; remote selection by TTL pulse

HEADSTAGES

Potential headstage:

Differential input (for suppression of bath potentials), cmr > 80 dB; Input resistance: $>10^{13} \Omega$; operating voltage ± 15 V
 Electrode connector: BNC with driven shield; driven shield range: ± 15 V, output impedance 250Ω
 Reference connector (bath): gold-plated SUBCLIC, grounded shield
 Ground connector: 2.3 mm connector or headstage enclosure
 Size: 65x25x25 mm, headstage enclosure is connected to ground
 Holding bar: diameter 8 mm, length 10 cm

Current headstage (standard voltage):

Operating voltage range: ± 150 V (standard)
 Input resistance: $>10^{12} \Omega$ (can be internally trimmed)
 Electrode connector: gold-plated SMC connector, grounded shield
 Size: 105x55x35 (150V)

Current range:

150 μ A / 1 M Ω (standard)
 Current range switch (optional): x0.1, x1, x2, x5 (other ranges available)

Bandwidth and speed of response:

Full power bandwidth ($R_{EL} = 0$): >100 kHz
 Rise time (10-90%): $<30 \mu$ s (current pulse of 100 μ A applied to $R_{EL} = 1$ M Ω)
 Bandwidth switch: wide band or 10 Hz for simultaneous patch clamp recordings

Current electrode parameter controls:

Offset compensation: ten-turn control, ± 500 mV

Potential electrode parameter controls:

Capacity compensation: range 0-30 pF, ten turn control
 Offset compensation: ± 300 mV, ten-turn control

POTENTIAL OUTPUTS

Potential electrode: sensitivity $\times 10$ mV, output impedance 50Ω ; output voltage range ± 15 V
 Current electrode: sensitivity $\times 10$ mV; output impedance 250Ω , output voltage range ± 15 V
 DISPLAY (switch selected): XXX mV

AUDIO MONITOR:

Pitch correlated with potential signals

OSCILLATION SHUT-OFF:

Turns off current injection and capacity compensation, function indicated by red / green LED, disabled / off / reset switch, threshold set with linear control (0-1200 mV)

ELECTRODE RESISTANCE TEST (both electrodes):

100 mV / $M\Omega$, obtained by application of square current pulses ± 10 nA, display XX.X $M\Omega$, selected automatically

CURRENT OUTPUTS:

Uncompensated output signal: sensitivity 0.1 V/ μ A, output impedance 50Ω , output voltage range ± 15 V
 Compensated /filtered output: sensitivity: 0.1...10 V / μ A (0.1, 0.2, 0.5, 1, 2, 5, 10 V / μ A) steps selected by rotary switch, with low-pass Bessel filter, output impedance 50Ω
 Sensitivity monitor: +1...+7 Volt, 1V / switch position, output impedance 50Ω
 DISPLAY: X.XX μ A

CURRENT OUTPUT FILTERS:

One-pole (standard version) or four-pole (TEC-03X-BF) low-pass Bessel filter
 16 corner frequencies: 20, 50, 100, 200, 300 500, 700, 1k, 1.3k, 2k, 3k, 5k, 8k, 10k, 13k, 20k Hz.
 Frequency monitor: -8...+7 V, 1 Volt / switch position, output impedance 50Ω

CURRENT CLAMP (standard current headstage):

Inputs: 1 μ A / V
 Input resistance: >100 k Ω
 HOLD: X.XX μ A, ten-turn digital control with -/0/+ switch, maximum 10 μ A.
Noise:
 Potential output: 100 μ V pp
 Current output: 200 pA pp with 1 $M\Omega$ resistance and 10 kHz bandwidth (internal four-pole Bessel filters)

Speed of response:

(1% settling time; potential output signals after application of square pulses of 1V with 1 M Ω electrode resistance)

Potential electrode: <10 μ s

Current electrode: <50 μ s

VOLTAGE CLAMP:

Input sensitivity: :10 mV

Input resistance >100 k Ω

HOLD: XXX mV, ten-turn digital control with +/- switch, maximum 1000 mV

RISE TIME LIMIT: 0-0.2 ms

GAIN: 10 μ A/V - 10000 μ A/V, ten-turn linear control.

INTEGRATOR TIME CONSTANT: 200 μ s - 2 ms, ten-turn control.

OUTPUT CURRENT LIMIT: 0-100% linear control.

NOISE (filters set to 10 kHz, other settings see below)

Potential output: <100 μ V pp

Current output: <10 nA pp at 10 kHz, <2 nA at 500 Hz

SPEED of RESPONSE (VC Mode):

1 % settling time: < 80 μ s for 10 mV step and < 100 μ s for 100 mV step applied to cell model ($R_{EL} = 1$ M Ω , $R_m = 100$ k Ω , $C_m = 0.1$ μ F, standard headstage)

POWER REQUIREMENTS:

115/230 V AC, 60 W (1.25 / 0.63 A fuse, SLOW)

DIMENSIONS:

19" rackmount cabinet, 19" (483 mm) wide, 14" (355 mm) deep, 5.25" (132.5 mm) high

WEIGHT: 8 kg

ACCESSORIES PROVIDED:

- ✓ Potential headstage, standard current headstage (other headstages may be substituted on request with order)
- ✓ Cable set and connectors for reference, current electrode and ground connectors
- ✓ Power cable
- ✓ User manual

OPTIONAL ACCESSORIES (ordered at additional cost):

- ⇨ TEC-EH: Electrode holder and –adapter (two holders without ports, one adapter for the current electrode holder)
- ⇨ TEC-MOD: passive cell model
- ⇨ TEC-MOD-A: active cell model
- ⇨ Headstages with four current ranges

Index

A	
Abbreviations	4
Absolute value optimum.....	52
AVO-method	52
B	
bandwidth	10
Basic settings	30
Bias Current Adjustment	33
breakout box	43
C	
cell model	30
connections	32
description	31
operation	32
CellWorks	8, 42
clamp performance	51
closed loop system.....	50
Components	8
control theory.....	50
current clamp mode	
overview	10
Current Injection and Measurement	10
D	
data acquisition boards	42
testing	43
E	
Electrical connections.....	29
electrodes	
capacity compensation.....	36
offset	35
positioning	46
resistance test.....	35
equivalent circuit amplifier.....	9
F	
features	8
front panel items	15
front panel view	14
H	
headstages	
connections	28
current headstage	26
options	28
potential headstage.....	25
potential headstage elements	25
J	
junction potential	35
L	
Linear optimum.....	52
linearity of response.....	55
LO-method	52
M	
MAX, NI test panel.....	42
Maximum speed of response	57
modulus hugging.....	50
N	
National Instruments (NI).....	42
O	
Offset Compensation	35
operation modes	10
testing	37
theory	50
tuning	38, 52
Optional accessories	8
Options	8
output current.....	51
P	
PI-controllers	50
Potential Registration.....	9
proportional gain.....	56
R	
rear panel items	21
rear panel items TEC-03X-CW	23
rear panel view.....	21
References.....	58
S	
Safety Regulations	6
sample experiment	47
series resistance compensation	12, 51
SO-method	52
specifications.....	69
speed of response	55

Symmetrical optimum	52	normal	12
		slow	12
T			
technical data	69	voltage clamp mode	10
test and tuning procedures	33	block diagram.....	11
time constants	55	control circuit.....	11
tip potential.....	35	improvements.....	12
Trouble Shooting	49	model circuit for oocyte.....	47
		overview.....	10
V			
voltage clamp control modes.....	11	theory	50
fast	12	tuning	38, 52